



Daikin Altherma low temperature split Technical Data

ERLA11-16DW1



TABLE OF CONTENTS

ERLA11-16DW1

1	Features	4
	ERLA11-16DW1	4
2	Specifications	5
3	Combination table	70
4	Capacity graphs	71
	Cooling Capacity Graphs	71
	Heating Capacity Graphs	72
	Heating Capacity Graphs - quiet mode	73
5	Capacity tables	74
	Certification Programs	74
	Domestic Hot Water performance	75
6	Dimensional drawings	76
7	Centre of gravity	77
8	Piping diagrams	78
9	Wiring diagrams	79
	Notes & Legend	79
	Compressor - Single phase	80
	Compressor - Three phase	81
10	Sound data	82
	Sound Pressure Spectrum - Cooling	82
	Sound Pressure Spectrum - Heating	83
	Sound Pressure Spectrum Quiet Mode	84
11	Installation	85
	Installation Method	85
12	Operation range	86

1 Features

1 - 1 ERLA11-16DW1

- › Outdoor unit extracts heat from the outdoor air, even at -25°C
- › Combining with R-32 Bluevolution technology, reduces environmental impact with 68% compared to R-410A, leads directly to lower energy consumption thanks to its high energy efficiency and has up to lower 16% refrigerant charge
- › W-LAN Adapter and cartridge connection (optional)
- › Black grille hiding the fan from view

1



Guaranteed operation down to -25°C



Daikin Residential Controller (optional)



Voice control

2 Specifications

1 - 1 ERLA11-16DW1

Technical specifications					EBBH11D6V + ERLA11DW1	EBBH16D6V + ERLA14DW1	EBBH16D6V + ERLA16DW1		
Heating capacity	Nom.			kW	10.6 (1) / 9.82 (2)	12.0 (1) / 12.5 (2)	16.0 (1) / 16.0 (2)		
Power input	Heating	Nom.		kW	2.18 (1) / 2.68 (2)	2.46 (1) / 3.42 (2)	3.53 (1) / 4.56 (2)		
COP					4.83 (1) / 3.66 (2)	4.87 (1) / 3.64 (2)	4.53 (1) / 3.51 (2)		
Pump	Nominal ESP unit	Heating		kPa	46.2 (3) / 47.7 (4)	62.8 (3) / 59.5 (4)	31.3 (3) / 31.3 (4)		
Water side Heat exchanger	Water flow rate	Heating	Nom.	l/min	29.3 (3) / 28.7 (4)	34.7 (3) / 36.1 (4)	46.1 (3) / 46.1 (4)		
General	Supplier/	Name and address			Daikin Europe N.V. - Zandvoordestraat 300, 8400 Oostende, Belgium				
	Manu- facturer details	Name or trademark			Daikin Europe N.V.				
Product descrip- tion	Air-to-water heat pump Brine-to-water heat pump Heat pump combination heater Low-temperature heat pump Supplementary heater integrated Water-to-water heat pump	Air-to-water heat pump			Yes				
		Brine-to-water heat pump			No				
		Heat pump combination heater			No				
		Low-temperature heat pump			No				
		Supplementary heater integrated			Yes				
LW(A) Sound power level (according to EN14825)	Indoor	Water-to-water heat pump			No				
		Indoor			44.0 (5)				
LW(A) Sound power level (according to EN14825)	Outdoor				62.0				
Sound condition Ecodesign and energy label					Sound power in heating mode, measured according to the EN12102 under conditions of the EN14825				
Space heating general	Air to water unit	Rated airflow (outdoor)	m ³ /h		3,350	4,220	5,100		
		Other	Capacity control		Inverter				
	Inte- grated supple- mentary heater	Pck (Crankcase heater mode)		kW		0.000			
		Poff (Off mode)		kW		0.023			
		Psb (Standby mode)		kW		0.023			
		Pto (Thermostat off)		kW		0.023			
	Inte- grated supple- mentary heater	Psup		kW		6.0			
		Type of energy input				Electrical			
	Space heating 	Average climate water outlet 55°C	General	Annual energy consumption	kWh		6,397	7,047	7,477
				ηs (Seasonal space heating efficiency)	%		126		
Prated at -10°C			Qhe Annual energy consumption (GCV)		Gj		23	25	27
			SCOP				3.23	3.22	3.32
Seasonal space heating eff. class					A++				
A Condition (7°CDB/-8°CWB)			Cd _h (Degradation heating)				1.0		
			COP _d				1.89	1.80	1.95
			Pd _h		kW		7.9	8.5	9.4
			PER _d		%		75.6	72.0	78.0
B Condition (2°CDB/1°CWB)			Cd _h (Degradation heating)				1.0		
			COP _d				3.25	3.28	3.27

2 Specifications

1 - 1 ERLA11-16DW1

Technical specifications				EBBH11D6V + ERLA11DW1	EBBH16D6V + ERLA14DW1	EBBH16D6V + ERLA16DW1		
Space heating	Average climate water outlet 55°C	B Condition (2°CDB/1°CWB)	Pdh	kW	5.4	6.2	6.9	
			PERd	%	130.0	131.2	130.8	
		C Condition (7°CDB/6°CWB)	CdH (Degradation heating)			1.0		
			COPd		4.81	4.88	4.93	
			Pdh	kW		4.4		
			PERd	%	192.4	195.2	197.2	
		D Condition (12°CDB/11°CWB)	CdH (Degradation heating)			1.0		
			COPd		6.41	6.58	6.60	
			Pdh	kW		5.3		
			PERd	%	256.4	263.2	264.0	
	Tol (temperature operating limit)	COPd			1.68	1.76	1.50	
		Pdh		kW	6.8	7.0	6.0	
		PERd		%	67.2	70.4	60.0	
		TOL		°C		-10		
	Cold climate water outlet 55°C	General	WTOL		°C		55	
			Rated heat output supplementary capacity		kW	3.2	4.0	6.1
			Tbiv (bivalent temperature)		°C			
			COPd			1.96	1.87	2.13
			Pdh		kW	8.2	8.9	10.1
		Warm climate water outlet 55°C	PERd		%	78.4	74.8	85.2
Tbiv			°C		-5			
Annual energy consumption			kWh	8,082	9,024	9,561		
ηs (Seasonal space heating efficiency)			%	119	117	121		
Prated at -22°C			kW	10	11	12		
Warm climate water outlet 55°C	General	Qhe Annual energy consumption (GCV)		Gj	29	32	34	
		Annual energy consumption		kWh	3,258	3,818	3,792	
		ηs (Seasonal space heating efficiency)		%	161	166	168	
		Prated at 2°C		kW	10		12.1	
		Qhe Annual energy consumption (GCV)		Gj	12		14	
	B Condition (2°CDB/1°CWB)	CdH (Degradation heating)			1.0			
		COPd		2.24	2.20	2.17		
		Pdh	kW	9.0	10.1	9.8		
		PERd	%	89.6	88.0	86.8		
		C Condition (7°CDB/6°CWB)	CdH (Degradation heating)			1.0		
COPd			3.74		3.83			
Pdh	kW		6.2		7.6			
PERd	%		149.6		153.2			
D Condition (12°CDB/11°CWB)	CdH (Degradation heating)			1.0				

2 Specifications

1 - 1 ERLA11-16DW1

Technical specifications				EBBH11D6V + ERLA11DW1	EBBH16D6V + ERLA14DW1	EBBH16D6V + ERLA16DW1
Space heating	Warm climate water outlet 55°C	D Condition (12°CDB/11°CWB)	COPd	5.68	5.69	
			Pdh kW		5.0	
			PERd %	227.2	227.6	
		Tbiv (bivalent temperature)	COPd	2.41	2.65	2.40
			Pdh kW	8.5	11.1	11.0
			PERd %	96.4	106.0	96.0
			Tbiv °C	4		3
Average climate water outlet 35°C	General	Annual energy consumption	kWh	4,462	4,935	5,377
		ηs (Seasonal space heating efficiency)	%	182	181	
		Prated at -10°C	kW	10	11	12
		Qhe Annual energy consumption (GCV)	Gj	16	18	19
		SCOP		4.63	4.60	4.61
		Seasonal space heating eff. class			A+++	
		A Condition (-7°CDB/-8°CWB)	COPd	3.03	2.99	2.87
			Pdh kW	9.2	9.8	11.2
	PERd %	121.2	119.6	114.8		
B Condition (2°CDB/1°CWB)	Cdh (Degradation heating)	COPd	4.37	4.35	4.33	
		Pdh kW	5.5	6.1	6.7	
		PERd %	174.8	174.0	173.2	
C Condition (7°CDB/6°CWB)	Cdh (Degradation heating)	COPd	6.74	6.70	6.83	
		Pdh kW	4.6		4.7	
		PERd %	269.6	268.0	273.2	
D Condition (12°CDB/11°CWB)	Cdh (Degradation heating)	COPd	8.54	8.65	8.82	
		Pdh kW	5.4		5.5	
		PERd %	341.6	346.0	352.8	
Tol (temperature operating limit)	COPd	COPd	2.73	2.71	2.52	
		Pdh kW	8.4	9.1	10.6	
		PERd %	109.2	108.4	100.8	
		TOL °C		-10		
		WTOL °C		35		
Tbiv (bivalent temperature)	COPd	COPd	3.01	2.99	2.72	
		Pdh kW	9.2	9.8	11.4	
		PERd %	120.4	119.6	108.8	
	Tbiv °C	-8	-7	-8		

2 Specifications

1 - 1 ERLA11-16DW1

2

Technical specifications				EBBH11D6V + ERLA11DW1	EBBH16D6V + ERLA14DW1	EBBH16D6V + ERLA16DW1	
Space heating	Average climate water outlet 35°C	Rated heat output supplementary capacity	Psup (at Tdesign -10°C)	kW	1.6	1.9	1.4
	Cold climate water outlet 35°C	General	Annual energy consumption	kWh	5,951	6,439	7,257
η_s (Seasonal space heating efficiency)			%	163	165	160	
Prated at -22°C			kW	10	11	12	
Qhe Annual energy consumption (GCV)			Gj	21	23	26	
Warm climate water outlet 35°C	General	Annual energy consumption	kWh	2,228	2,431	2,675	
		η_s (Seasonal space heating efficiency)	%	236	239	237	
		Prated at 2°C	kW	10	11	12	
		Qhe Annual energy consumption (GCV)	Gj	8	9	10	
B Condition (2°CDB/1°CWB)	Cd	Cd (Degradation heating)			1.0		
		COPd		3.64	3.51	3.30	
C Condition (7°CDB/6°CWB)	Cd	Cd (Degradation heating)			1.0		
		COPd		5.70	5.77	5.64	
Tbiv (bivalent temperature)	Pd	Pd (Degradation heating)			9.8	11.0	11.9
		PERd	%	145.6	140.4	132.0	
D Condition (12°CDB/11°CWB)	Cd	Cd (Degradation heating)			1.0		
		COPd		7.87	7.73	7.73	
	Pd	Pd (Degradation heating)			9.2	11.0	11.9
		PERd	%	152.4	140.4	132.0	
	Tbiv	Tbiv (bivalent temperature)		°C	3	2	2
	PERd	PERd (Seasonal space heating efficiency)		%	314.8	309.2	309.2

(1)Condition: Ta DB/WB 7°C/6°C - LWC 35°C (DT = 5°C) |

(2)Condition: Ta DB/WB 7°C/6°C - LWC 45°C (DT=5°C) |

(3)Condition 1: cooling Ta 35°C - LWE 18°C (DT = 5°C); heating Ta DB/WB 7°C/6°C - LWC 35°C (DT = 5°C) |

(4)Condition 2: cooling Ta 35°C - LWE 7°C (DT = 5°C); heating Ta DB/WB 7°C/6°C - LWC 45°C (DT = 5°C) |

(5)Measured with a pressure drop of 10 kPa in the heating system at an operating condition of leaving water 47-55°C in a room with an ambient of 20°C. DB/WB 7°C/6°C. |

Cooling: EW 12°C; LW 7°C; ambient conditions: 35°CDB |

Cooling: EW 23°C; LW 18°C; ambient conditions: 35°CDB |

According to EN14825

Technical specifications				EBBH11D9W + ERLA11DW1	EBBH16D9W + ERLA14DW1	EBBH16D9W + ERLA16DW1		
Heating capacity	Nom.			kW	10.6 (1) / 9.82 (2)	12.0 (1) / 12.5 (2)	16.0 (1) / 16.0 (2)	
Power input	Heating	Nom.		kW	2.18 (1) / 2.68 (2)	2.46 (1) / 3.42 (2)	3.53 (1) / 4.56 (2)	
					COP	4.83 (1) / 3.66 (2)	4.87 (1) / 3.64 (2)	4.53 (1) / 3.51 (2)
Pump	Nominal ESP unit	Heating		kPa	46.2 (3) / 47.7 (4)	62.8 (3) / 59.5 (4)	31.3 (3) / 31.3 (4)	
Water side Heat exchanger	Water flow rate	Heating	Nom.	l/min	29.3 (3) / 28.7 (4)	34.7 (3) / 36.1 (4)	46.1 (3) / 46.1 (4)	
General	Supplier/Manufacturer details	Name and address		Daikin Europe N.V. - Zandvoordestraat 300, 8400 Oostende, Belgium				
		Name or trademark		Daikin Europe N.V.				
	Product description	Air-to-water heat pump			Yes			
		Brine-to-water heat pump			No			
		Heat pump combination heater			No			
		Low-temperature heat pump			No			
		Supplementary heater integrated			Yes			
Water-to-water heat pump			No					
LW(A) Sound power level (according to EN14825)	Indoor			dB(A)	44.0 (5)			

2 Specifications

1 - 1 ERLA11-16DW1

Technical specifications				EBBH11D9W + ERLA11DW1	EBBH16D9W + ERLA14DW1	EBBH16D9W + ERLA16DW1	
LW(A) Sound power level (according to EN14825)	Outdoor		dB(A)	62.0			
Sound condition Ecodesign and energy label				Sound power in heating mode, measured according to the EN12102 under conditions of the EN14825			
Space heating general	Air to water unit	Rated airflow (outdoor)	m ³ /h	3,350	4,220	5,100	
	Other	Capacity control		Inverter			
		Pck (Crankcase heater mode)	kW	0.000			
		Poff (Off mode)	kW	0.023			
		Psb (Standby mode)	kW	0.023			
		Pto (Thermostat off)	kW	0.023			
	Integrated supplementary heater	Psup	kW	9.0			
		Type of energy input		Electrical			
Space heating 	Average climate water outlet 55°C	General	Annual energy consumption	kWh	6,397	7,047	7,477
			ηs (Seasonal space heating efficiency)	%	126		130
			Prated at -10°C	kW	10	11	12
			Qhe Annual energy consumption (GCV)	Gj	23	25	27
			SCOP		3.23	3.22	3.32
			Seasonal space heating eff. class		A++		
		A Condition (7°CDB/-8°CWB)	Cdh (Degradation heating)		1.0		
			COPd		1.89	1.80	1.95
			Pdh	kW	7.9	8.5	9.4
			PERd	%	75.6	72.0	78.0
B Condition (2°CDB/1°CWB)	Cdh (Degradation heating)		1.0				
	COPd		3.25	3.28	3.27		

2 Specifications

1 - 1 ERLA11-16DW1

2

Technical specifications				EBBH11D9W + ERLA11DW1	EBBH16D9W + ERLA14DW1	EBBH16D9W + ERLA16DW1		
Space heating	Average climate water outlet 55°C	B Condition (2°CDB/1°CWB)	Pdh	kW	5.4	6.2	6.9	
			PERd	%	130.0	131.2	130.8	
		C Condition (7°CDB/6°CWB)	CdH (Degradation heating)			1.0		
			COPd		4.81	4.88	4.93	
			Pdh	kW		4.4		
			PERd	%	192.4	195.2	197.2	
		D Condition (12°CDB/11°CWB)	CdH (Degradation heating)			1.0		
			COPd		6.41	6.58	6.60	
			Pdh	kW		5.3		
		Tol (temperature operating limit)	COPd			1.68	1.76	1.50
	Pdh		kW	6.8	7.0	6.0		
	PERd		%	67.2	70.4	60.0		
	TOL		°C		-10			
	Cold climate water outlet 55°C	Rated heat output supplementary capacity	Psup (at Tdesign -10°C)		kW	3.2	4.0	6.1
			COPd			1.96	1.87	2.13
			Pdh		kW	8.2	8.9	10.1
			PERd		%	78.4	74.8	85.2
			Tbiv		°C		-5	
		General	Annual energy consumption		kWh	8,082	9,024	9,561
			ηs (Seasonal space heating efficiency)		%	119	117	121
Prated at -22°C			kW	10	11	12		
Qhe Annual energy consumption (GCV)			Gj	29	32	34		
Tbiv			°C		-5			
Warm climate water outlet 55°C	General	Annual energy consumption		kWh	3,258	3,818	3,792	
		ηs (Seasonal space heating efficiency)		%	161	166	168	
		Prated at 2°C		kW	10		12.1	
		Qhe Annual energy consumption (GCV)		Gj	12		14	
		Tbiv		°C		-5		
	B Condition (2°CDB/1°CWB)	CdH (Degradation heating)			1.0			
		COPd		2.24	2.20	2.17		
		Pdh	kW	9.0	10.1	9.8		
		PERd	%	89.6	88.0	86.8		
		CdH (Degradation heating)			1.0			
C Condition (7°CDB/6°CWB)	COPd			3.74	3.83			
	Pdh	kW	6.2		7.6			
	PERd	%	149.6		153.2			
D Condition (12°CDB/11°CWB)	CdH (Degradation heating)			1.0				

2 Specifications

1 - 1 ERLA11-16DW1

Technical specifications				EBBH11D9W + ERLA11DW1	EBBH16D9W + ERLA14DW1	EBBH16D9W + ERLA16DW1	
Space heating	Warm climate water outlet 55°C	D Condition (12°CDB/11°CWB)	COPd	5.68	5.69		
			Pdh kW		5.0		
			PERd %	227.2	227.6		
		Tbiv (bivalent temperature)	COPd	2.41	2.65	2.40	
			Pdh kW	8.5	11.1	11.0	
			PERd %	96.4	106.0	96.0	
			Tbiv °C	4		3	
Average climate water outlet 35°C	General	Annual energy consumption		4,462	4,935	5,377	
		ηs (Seasonal space heating efficiency)		182	181		
		Prated at -10°C kW		10	11	12	
		Qhe Annual energy consumption (GCV) GJ		16	18	19	
		SCOP		4.63	4.60	4.61	
		Seasonal space heating eff. class			A+++		
		A Condition (-7°CDB/-8°CWB)	COPd		3.03	2.99	2.87
			Pdh kW		9.2	9.8	11.2
			PERd %		121.2	119.6	114.8
		B Condition (2°CDB/1°CWB)	Cd (Degradation heating)			1.0	
COPd			4.37	4.35	4.33		
Pdh kW			5.5	6.1	6.7		
C Condition (7°CDB/6°CWB)	Cd (Degradation heating)			1.0			
	COPd		6.74	6.70	6.83		
	Pdh kW		4.6	4.6	4.7		
D Condition (12°CDB/11°CWB)	Cd (Degradation heating)			1.0			
	COPd		8.54	8.65	8.82		
	Pdh kW		5.4	5.4	5.5		
Tol (temperature operating limit)	PERd %		341.6	346.0	352.8		
	COPd		2.73	2.71	2.52		
	Pdh kW		8.4	9.1	10.6		
Tbiv (bivalent temperature)	PERd %		109.2	108.4	100.8		
	TOL °C			-10			
	WTOL °C			35			
Tbiv (bivalent temperature)	COPd		3.01	2.99	2.72		
	Pdh kW		9.2	9.8	11.4		
	PERd %		120.4	119.6	108.8		
			Tbiv °C	-8	-7	-8	

2 Specifications

1 - 1 ERLA11-16DW1

2

Technical specifications				EBBH11D9W + ERLA11DW1	EBBH16D9W + ERLA14DW1	EBBH16D9W + ERLA16DW1		
Space heating	Average climate water outlet 35°C	Rated heat output supplementary capacity	Psup (at Tdesign -10°C)	kW	1.6	1.9	1.4	
Cold climate water outlet 35°C	General	Annual energy consumption	ηs (Seasonal space heating efficiency)	kWh	5,951	6,439	7,257	
				%	163	165	160	
				Prated at -22°C	kW	10	11	12
				Qhe Annual energy consumption (GCV)	Gj	21	23	26
Warm climate water outlet 35°C	General	Annual energy consumption	ηs (Seasonal space heating efficiency)	kWh	2,228	2,431	2,675	
				%	236	239	237	
				Prated at 2°C	kW	10	11	12
				Qhe Annual energy consumption (GCV)	Gj	8	9	10
B Condition (2°CDB/1°CWB)	Cd	COPd	Pd	Cdh (Degradation heating)	1.0			
				kW	3.64	3.51	3.30	
				%	9.8	11.0	11.9	
C Condition (7°CDB/6°CWB)	Cd	COPd	Pd	Cdh (Degradation heating)	1.0			
				kW	5.70	5.77	5.64	
				%	6.7	7.4	8.1	
Tbiv (bivalent temperature)	COPd	Pd	PERd	Tbiv	228.0	230.8	225.6	
				kW	3.81	3.51	3.30	
				%	9.2	11.0	11.9	
D Condition (12°CDB/11°CWB)	COPd	Pd	PERd	Tbiv	152.4	140.4	132.0	
				°C	3		2	
				Cdh (Degradation heating)	1.0			
	COPd	Pd	PERd		7.87		7.73	
				kW		5.2		
				%	314.8		309.2	

(1)Condition: Ta DB/WB 7°C/6°C - LWC 35°C (DT = 5°C) |

(2)Condition: Ta DB/WB 7°C/6°C - LWC 45°C (Dt=5°C) |

(3)Condition 1: cooling Ta 35°C - LWE 18°C (DT = 5°C); heating Ta DB/WB 7°C/6°C - LWC 35°C (DT = 5°C) |

(4)Condition 2: cooling Ta 35°C - LWE 7°C (DT = 5°C); heating Ta DB/WB 7°C/6°C - LWC 45°C (DT = 5°C) |

(5)Measured with a pressure drop of 10 kPa in the heating system at an operating condition of leaving water 47-55°C in a room with an ambient of 20°C. DB/WB 7°C/6°C. |

Cooling: EW 12°C; LW 7°C; ambient conditions: 35°CDB |

Cooling: EW 23°C; LW 18°C; ambient conditions: 35°CDB |

According to EN14825

Technical specifications				EBBX11D6V + ERLA11DW1	EBBX16D6V + ERLA14DW1	EBBX16D6V + ERLA16DW1	
SEER				5.92 (5)	5.89 (5)	5.76 (5)	
Heating capacity	Nom.		kW	10.6 (1) / 9.82 (2)	12.0 (1) / 12.5 (2)	16.0 (1) / 16.0 (2)	
Cooling capacity	Nom.		kW	11.2 (3) / 12.0 (4)	13.1 (3) / 13.3 (4)	13.8 (3) / 15.9 (4)	
Power input	Heating	Nom.	kW	2.18 (1) / 2.68 (2)	2.46 (1) / 3.42 (2)	3.53 (1) / 4.56 (2)	
	Cooling	Nom.	kW	3.43 (3) / 2.52 (4)	4.32 (3) / 2.86 (4)	4.68 (3) / 3.82 (4)	
COP				4.83 (1) / 3.66 (2)	4.87 (1) / 3.64 (2)	4.53 (1) / 3.51 (2)	
EER				3.26 (3) / 4.75 (4)	3.02 (3) / 4.66 (4)	2.94 (3) / 4.16 (4)	
Pump	Nominal	Cooling	kPa	35.2 (6) / 38.8 (7)	56.6 (6) / 56.8 (7)	37.0 (6) / 50.3 (7)	
	ESP unit	Heating	kPa	46.2 (6) / 47.7 (7)	62.8 (6) / 59.5 (7)	31.3 (6) / 31.3 (7)	
Water side Heat exchanger	Water flow rate	Cooling	Nom.	l/min	33.5 (6) / 32.2 (7)	37.3 (6) / 37.2 (7)	44.3 (6) / 39.7 (7)
		Heating	Nom.	l/min	29.3 (6) / 28.7 (7)	34.7 (6) / 36.1 (7)	46.1 (6) / 46.1 (7)

2 Specifications

1 - 1 ERLA11-16DW1

Technical specifications				EBBX11D6V + ERLA11DW1	EBBX16D6V + ERLA14DW1	EBBX16D6V + ERLA16DW1	
General	Supplier/ Manufacturer details	Name and address		Daikin Europe N.V. - Zandvoordestraat 300, 8400 Oostende, Belgium			
		Name or trademark		Daikin Europe N.V.			
	Product description	Air-to-water heat pump			Yes		
		Brine-to-water heat pump			No		
		Heat pump combination heater			No		
		Low-temperature heat pump			No		
		Supplementary heater integrated			Yes		
	LW(A) Sound power level (according to EN14825)	Indoor			44.0 (8)		
			dB(A)				
	LW(A) Sound power level (according to EN14825)	Outdoor			62.0		
		dB(A)					
Sound condition Ecodesign and energy label				Sound power in heating mode, measured according to the EN12102 under conditions of the EN14825			
Space heating general	Air to water unit	Rated airflow (outdoor)	m ³ /h	3,350	4,220	5,100	
	Other	Capacity control			Inverter		
		Pck (Crankcase heater mode) kW			0.000		
		Poff (Off mode) kW			0.023		
		Psb (Standby mode) kW			0.023		
		Pto (Thermostat off) kW			0.023		
	Integrated supplementary heater	Psup			6.0		
Type of energy input					Electrical		
Space heating 	Average climate water outlet 55°C	General	Annual energy consumption	kWh	6,312	6,962	7,392
			ηs (Seasonal space heating efficiency)	%	128		131
			Prated at -10°C	kW	10	11	12
			Qhe Annual energy consumption (GCV)	Gj	23	25	27
			SCOP		3.27	3.26	3.35
			Seasonal space heating eff. class			A++	

2 Specifications

1 - 1 ERLA11-16DW1

Technical specifications				EBBX11D6V + ERLA11DW1	EBBX16D6V + ERLA14DW1	EBBX16D6V + ERLA16DW1	
Space heating	Average climate water outlet 55°C	A Condition (7°CDB/-8°CWB)	Cdh (Degradation heating)		1.0		
			COPd	1.89	1.80	1.95	
			Pdh kW	7.9	8.5	9.4	
		B Condition (2°CDB/-11°CWB)	PERd %	75.6	72.0	78.0	
			Cdh (Degradation heating)		1.0		
			COPd	3.25	3.28	3.27	
		C Condition (7°CDB/-6°CWB)	Pdh kW	5.4	6.2	6.9	
			PERd %	130.0	131.2	130.8	
			Cdh (Degradation heating)		1.0		
		D Condition (12°CDB/11°CWB)	COPd	4.81	4.88	4.93	
			Pdh kW		4.4		
			PERd %	192.4	195.2	197.2	
		Tol (temperature operating limit)		Cdh (Degradation heating)		1.0	
				COPd	6.41	6.58	6.60
				Pdh kW		5.3	
				PERd %	256.4	263.2	264.0
				COPd	1.68	1.76	1.50
				Pdh kW	6.8	7.0	6.0
		Rated heat output supplementary capacity		PERd %	67.2	70.4	60.0
				TOL °C		-10	
		Cold climate water outlet 55°C	General	WTOL °C		55	
				Psup (at Tdesign -10°C) kW	3.2	4.0	6.1
				Tbiv COPd	1.96	1.87	2.13
Pdh kW	8.2			8.9	10.1		
PERd %	78.4			74.8	85.2		
Warm climate water outlet 55°C	General	Tbiv °C		-5			
		Annual energy consumption kWh	8,031	8,974	9,510		
		ηs (Seasonal space heating efficiency) %	120	118	121		
		Prated at -22°C kW	10	11	12		
		Qhe Annual energy consumption (GCV) GJ	29	32	34		
		Annual energy consumption kWh	3,157	3,717	3,690		
		ηs (Seasonal space heating efficiency) %	166	171	172		
B Condition (2°CDB/11°CWB)		Prated at 2°C kW	10	12.1			
		Qhe Annual energy consumption (GCV) GJ	11	13			
		Cdh (Degradation heating)		1.0			
		COPd	2.24	2.20	2.17		
		Pdh kW	9.0	10.1	9.8		

2 Specifications

1 - 1 ERLA11-16DW1

Technical specifications				EBBX11D6V + ERLA11DW1	EBBX16D6V + ERLA14DW1	EBBX16D6V + ERLA16DW1	
Space heating 	Warm climate water outlet 55°C	B Condition (2°CDB/1°CWB)	PERd %	89.6	88.0	86.8	
		C Condition (7°CDB/1°CWB)	CdH (Degradation heating)		1.0		
			COPd		3.74	3.83	
			Pdh kW		6.2	7.6	
		D Condition (12°CDB/11°CWB)	CdH (Degradation heating)		1.0		
			COPd		5.68	5.69	
	Pdh kW			5.0	5.0		
	Average climate water outlet 35°C	General	Annual energy consumption		4,378	4,851	5,293
			ηs (Seasonal space heating efficiency)		186	184	
			Prated at -10°C		10	11	12
			Qhe Annual energy consumption (GCV)		16	17	19
	Tol (temperature operating limit)	A Condition (-7°CDB/-8°CWB)	SCOP		4.72	4.68	
			Seasonal space heating eff. class		A+++		
			COPd		3.03	2.99	2.87
B Condition (2°CDB/1°CWB)		PdH kW		9.2	9.8	11.2	
		PERd %		121.2	119.6	114.8	
		CdH (Degradation heating)		1.0			
C Condition (7°CDB/6°CWB)		COPd		4.37	4.35	4.33	
		PdH kW		5.5	6.1	6.7	
		PERd %		174.8	174.0	173.2	
D Condition (12°CDB/11°CWB)		CdH (Degradation heating)		1.0			
		COPd		6.74	6.70	6.83	
		PdH kW		4.6	4.6	4.7	
Tol (temperature operating limit)		PERd %		269.6	268.0	273.2	
		CdH (Degradation heating)		1.0			
	COPd		8.54	8.65	8.82		
Tol (temperature operating limit)	PdH kW		5.4	5.4	5.5		
	PERd %		341.6	346.0	352.8		
	COPd		2.73	2.71	2.52		
Tol (temperature operating limit)	PdH kW		8.4	9.1	10.6		
	PERd %		109.2	108.4	100.8		

2 Specifications

1 - 1 ERLA11-16DW1

2

Technical specifications					EBBX11D6V + ERLA11DW1	EBBX16D6V + ERLA14DW1	EBBX16D6V + ERLA16DW1
Space heating Average climate water outlet 35°C	Tol (temperature operating limit)	TOL	°C		-10		
		WTOL	°C		35		
	(bivalent temperature)	Tbiv	COPd		3.01	2.99	2.72
		Pdh	kW		9.2	9.8	11.4
	Rated heat output supplementary capacity	PERd	%		120.4	119.6	108.8
		Tbiv	°C		-8	-7	-8
	Cold climate water outlet 35°C	General	Psup (at Tdesign -10°C)	kW	1.6	1.9	1.4
			Annual energy consumption	kWh	5,901	6,388	7,206
	Warm climate water outlet 35°C	General	ηs (Seasonal space heating efficiency)	%	164	167	161
			Prated at -22°C	kW	10	11	12
Annual energy consumption (GCV)		Qhe	Gj	21	23	26	
		Annual energy consumption	kWh	2,126	2,330	2,573	
ηs (Seasonal space heating efficiency)		Prated at 2°C	kW	10	11	12	
		Qhe Annual energy consumption (GCV)	Gj	8		9	
B Condition (2°CDB-B/1°CWB)		Cd (Degradation heating)	COPd		1.0		
			Pdh	kW	3.64	3.51	3.30
C Condition (7°CDB-B/6°CWB)		Cd (Degradation heating)	Pdh	kW	9.8	11.0	11.9
			PERd	%	145.6	140.4	132.0
D Condition (12°CDB/11°CWB)	Cd (Degradation heating)	COPd		1.0			
		Pdh	kW	5.70	5.77	5.64	
(bivalent temperature)	PERd	Pdh	kW	6.7	7.4	8.1	
		PERd	%	228.0	230.8	225.6	
Tbiv	COPd	Tbiv	°C	3.81	3.51	3.30	
		Pdh	kW	9.2	11.0	11.9	
Tbiv	PERd	Pdh	kW	152.4	140.4	132.0	
		PERd	%	3		2	
D Condition (12°CDB/11°CWB)	Cd (Degradation heating)	COPd		1.0			
		Pdh	kW	7.87	5.2	7.73	
PERd	PERd	Pdh	kW	314.8		309.2	
		PERd	%				

(1)Condition: Ta DB/WB 7°C/6°C - LWC 35°C (DT = 5°C) |

(2)Condition: Ta DB/WB 7°C/6°C - LWC 45°C (Dt=5°C) |

(3)Cooling: EW 12°C; LW 7°C; ambient conditions: 35°CDB |

(4)Cooling: EW 23°C; LW 18°C; ambient conditions: 35°CDB |

(5)According to EN14825 |

(6)Condition 1: cooling Ta 35°C - LWE 18°C (DT = 5°C); heating Ta DB/WB 7°C/6°C - LWC 35°C (DT = 5°C) |

(7)Condition 2: cooling Ta 35°C - LWE 7°C (DT = 5°C); heating Ta DB/WB 7°C/6°C - LWC 45°C (DT = 5°C) |

(8)Measured with a pressure drop of 10 kPa in the heating system at an operating condition of leaving water 47-55°C in a room with an ambient of 20°C. DB/WB 7°C/6°.

Technical specifications					EBBX11D9W + ERLA11DW1	EBBX16D9W + ERLA14DW1	EBBX16D9W + ERLA16DW1
SEER					5.92 (5)	5.89 (5)	5.76 (5)
Heating capacity	Nom.		kW		10.6 (1) / 9.82 (2)	12.0 (1) / 12.5 (2)	16.0 (1) / 16.0 (2)
Cooling capacity	Nom.		kW		11.2 (3) / 12.0 (4)	13.1 (3) / 13.3 (4)	13.8 (3) / 15.9 (4)
Power input	Heating	Nom.	kW		2.18 (1) / 2.68 (2)	2.46 (1) / 3.42 (2)	3.53 (1) / 4.56 (2)
	Cooling	Nom.	kW		3.43 (3) / 2.52 (4)	4.32 (3) / 2.86 (4)	4.68 (3) / 3.82 (4)
COP					4.83 (1) / 3.66 (2)	4.87 (1) / 3.64 (2)	4.53 (1) / 3.51 (2)
EER					3.26 (3) / 4.75 (4)	3.02 (3) / 4.66 (4)	2.94 (3) / 4.16 (4)
Pump	Nominal	Cooling	kPa		35.2 (6) / 38.8 (7)	56.6 (6) / 56.8 (7)	37.0 (6) / 50.3 (7)
	ESP unit	Heating	kPa		46.2 (6) / 47.7 (7)	62.8 (6) / 59.5 (7)	31.3 (6) / 31.3 (7)
Water side Heat exchanger	Water flow rate	Cooling	Nom.	l/min	33.5 (6) / 32.2 (7)	37.3 (6) / 37.2 (7)	44.3 (6) / 39.7 (7)
		Heating	Nom.	l/min	29.3 (6) / 28.7 (7)	34.7 (6) / 36.1 (7)	46.1 (6) / 46.1 (7)

2 Specifications

1 - 1 ERLA11-16DW1

Technical specifications				EBBX11D9W + ERLA11DW1	EBBX16D9W + ERLA14DW1	EBBX16D9W + ERLA16DW1	
General	Supplier/Manu- facturer details	Name and address		Daikin Europe N.V. - Zandvoordestraat 300, 8400 Oostende, Belgium			
		Name or trademark		Daikin Europe N.V.			
	Product descrip- tion	Air-to-water heat pump		Yes			
		Brine-to-water heat pump		No			
		Heat pump combination heater		No			
		Low-temperature heat pump		No			
		Supplementary heater integrated		Yes			
	LW(A) Sound power level (according to EN14825)	Indoor	dB(A)	44.0 (8)			
				62.0			
	LW(A) Sound pow- er level (according to EN14825)	Outdoor	dB(A)	62.0			
Sound condition Ecodesign and energy label				Sound power in heating mode, measured according to the EN12102 under conditions of the EN14825			
Space heating general	Air to water unit	Rated airflow (outdoor)	m ³ /h	3,350	4,220	5,100	
		Other	Capacity control		Inverter		
	Pck (Crankcase heater mode) kW		0.000				
	Poff (Off mode) kW		0.023				
	Psb (Standby mode) kW		0.023				
	Pto (Thermostat off) kW		0.023				
	Inte- grated supple- mentary heater	Psup kW		9.0			
Type of energy input		Electrical					
Space heating 	Average climate water outlet 55°C	General	Annual energy consumption	kWh	6,312	6,962	7,392
			ηs (Seasonal space heating efficiency)	%	128		131
		Prated at -10°C		kW	10	11	12
		Qhe Annual energy consumption (GCV)		Gj	23	25	27
		SCOP			3.27	3.26	3.35
		Seasonal space heating eff. class			A++		

2 Specifications

1 - 1 ERLA11-16DW1

Technical specifications				EBBX11D9W + ERLA11DW1	EBBX16D9W + ERLA14DW1	EBBX16D9W + ERLA16DW1
Space heating	Average climate water outlet 55°C	A Condition (7°CDB/-8°CWB)	Cdh (Degradation heating)		1.0	
			COPd	1.89	1.80	1.95
			Pdh kW	7.9	8.5	9.4
		PERd %	75.6	72.0	78.0	
		B Condition (2°CDB/-B/1°CWB)	Cdh (Degradation heating)		1.0	
			COPd	3.25	3.28	3.27
			Pdh kW	5.4	6.2	6.9
		PERd %	130.0	131.2	130.8	
		C Condition (7°CDB/-B/6°CWB)	Cdh (Degradation heating)		1.0	
			COPd	4.81	4.88	4.93
	Pdh kW			4.4		
	PERd %	192.4	195.2	197.2		
	D Condition (12°CDB/11°CWB)	Cdh (Degradation heating)		1.0		
		COPd	6.41	6.58	6.60	
		Pdh kW		5.3		
	PERd %	256.4	263.2	264.0		
	Tol (temperature operating limit)	COPd	1.68	1.76	1.50	
		Pdh kW	6.8	7.0	6.0	
		PERd %	67.2	70.4	60.0	
	TOL °C		-10			
WTOL °C		55				
Rated heat output supplementary capacity	Psup (at Tdesign -10°C) kW	3.2	4.0	6.1		
	Tbiv (bivalent temperature) °C	COPd	1.96	1.87	2.13	
		Pdh kW	8.2	8.9	10.1	
		PERd %	78.4	74.8	85.2	
		Tbiv °C		-5		
Cold climate water outlet 55°C	General	Annual energy consumption kWh	8,031	8,974	9,510	
		ηs (Seasonal space heating efficiency) %	120	118	121	
		Prated at -22°C kW	10	11	12	
		Qhe Annual energy consumption (GCV) GJ	29	32	34	
		Annual energy consumption kWh	3,157	3,717	3,690	
Warm climate water outlet 55°C	General	Annual energy consumption kWh	3,157	3,717	3,690	
		ηs (Seasonal space heating efficiency) %	166	171	172	
		Prated at 2°C kW	10		12.1	
		Qhe Annual energy consumption (GCV) GJ	11		13	
		B Condition (2°CDB/1°CWB)	Cdh (Degradation heating)		1.0	
COPd	2.24		2.20	2.17		
Pdh kW	9.0		10.1	9.8		

2 Specifications

1 - 1 ERLA11-16DW1

Technical specifications				EBBX11D9W + ERLA11DW1	EBBX16D9W + ERLA14DW1	EBBX16D9W + ERLA16DW1			
Space heating 	Warm climate water outlet 55°C	B Condition (2°CDB/1°CWB)	PERd %	89.6	88.0	86.8			
		C Condition (7°CDB/6°CWB)	Cdh (Degradation heating)		1.0				
			COPd		3.74		3.83		
			Pdh kW		6.2		7.6		
		D Condition (12°CDB/11°CWB)	PERd %		149.6		153.2		
			Cdh (Degradation heating)		1.0				
			COPd		5.68		5.69		
		Tbiv (bivalent temperature)	Tbiv °C	Pdh kW		5.0			
				PERd %		227.2		227.6	
				COPd		2.41	2.65	2.40	
				Pdh kW		8.5	11.1	11.0	
		Average climate water outlet 35°C	General	Annual energy consumption	PERd %	96.4	106.0	96.0	
					Tbiv °C		4		3
					Annual energy consumption kWh		4,378	4,851	5,293
ηs (Seasonal space heating efficiency) %					186		184		
Prated at -10°C kW					10	11	12		
Qhe Annual energy consumption (GCV) GJ					16	17	19		
SCOP					4.72		4.68		
Seasonal space heating eff. class					A+++				
A Condition (-7°CDB/-8°CWB)	COPd					3.03	2.99	2.87	
	Pdh kW					9.2	9.8	11.2	
	PERd %					121.2	119.6	114.8	
B Condition (2°CDB/1°CWB)	Cdh (Degradation heating)					1.0			
	COPd					4.37	4.35	4.33	
	Pdh kW					5.5	6.1	6.7	
C Condition (7°CDB/6°CWB)	PERd %		174.8	174.0	173.2				
	Cdh (Degradation heating)		1.0						
	COPd		6.74	6.70	6.83				
D Condition (12°CDB/11°CWB)	Pdh kW			4.6	4.7				
	PERd %		269.6	268.0	273.2				
	Cdh (Degradation heating)		1.0						
Tol (temperature operating limit)	Tol (temperature operating limit)	COPd		8.54	8.65	8.82			
		Pdh kW			5.4	5.5			
		PERd %		341.6	346.0	352.8			
Tol (temperature operating limit)	Tol (temperature operating limit)	COPd		2.73	2.71	2.52			
		Pdh kW		8.4	9.1	10.6			
		PERd %		109.2	108.4	100.8			

2 Specifications

1 - 1 ERLA11-16DW1

2

Technical specifications					EBBX11D9W + ERLA11DW1	EBBX16D9W + ERLA14DW1	EBBX16D9W + ERLA16DW1	
Space heating	Average climate water outlet 35°C	Tol (temperature operating limit)	TOL	°C		-10		
			WTOL	°C		35		
		(bivalent temperature)	Tbiv	COPd		3.01	2.99	2.72
			Pdh	kW		9.2	9.8	11.4
		Rated heat output supplementary capacity	PERd	%		120.4	119.6	108.8
			Tbiv	°C		-8	-7	-8
		Cold climate water outlet 35°C	General	Psup (at Tdesign -10°C)	kW	1.6	1.9	1.4
				Annual energy consumption	kWh	5,901	6,388	7,206
		Warm climate water outlet 35°C	General	ηs (Seasonal space heating efficiency)	%	164	167	161
				Prated at -22°C	kW	10	11	12
Qhe Annual energy consumption (GCV)	Gj			21	23	26		
Annual energy consumption	kWh			2,126	2,330	2,573		
ηs (Seasonal space heating efficiency)	%			248	249	246		
Prated at 2°C	kW			10	11	12		
Qhe Annual energy consumption (GCV)	Gj				8	9		
B Condition (2°CDB-B/1°CWB)	Cd (Degradation heating)			COPd		3.64	3.51	3.30
				Pdh	kW	9.8	11.0	11.9
C Condition (7°CDB-B/6°CWB)	Cd (Degradation heating)			PERd	%	145.6	140.4	132.0
		COPd		5.70	5.77	5.64		
D Condition (12°CDB/11°CWB)	Cd (Degradation heating)	Pdh	kW	6.7	7.4	8.1		
		PERd	%	228.0	230.8	225.6		
	Tbiv (bivalent temperature)	COPd		3.81	3.51	3.30		
		Pdh	kW	9.2	11.0	11.9		
	PERd	PERd	%	152.4	140.4	132.0		
		Tbiv	°C	3		2		
	COPd	COPd		7.87		7.73		
		Pdh	kW		5.2			
	PERd	PERd	%	314.8		309.2		

(1)Condition: Ta DB/WB 7°C/6°C - LWC 35°C (DT = 5°C) |

(2)Condition: Ta DB/WB 7°C/6°C - LWC 45°C (DT=5°C) |

(3)Cooling: EW 12°C; LW 7°C; ambient conditions: 35°CDB |

(4)Cooling: EW 23°C; LW 18°C; ambient conditions: 35°CDB |

(5)According to EN14825 |

(6)Condition 1: cooling Ta 35°C - LWE 18°C (DT = 5°C); heating Ta DB/WB 7°C/6°C - LWC 35°C (DT = 5°C) |

(7)Condition 2: cooling Ta 35°C - LWE 7°C (DT = 5°C); heating Ta DB/WB 7°C/6°C - LWC 45°C (DT = 5°C) |

(8)Measured with a pressure drop of 10 kPa in the heating system at an operating condition of leaving water 47-55°C in a room with an ambient of 20°C. DB/WB 7°C/6°.

Technical specifications					EBVH11S18D6V + ERLA11DW1	EBVH11S23D6V + ERLA11DW1	EBVH16S18D6V + ERLA14DW1	EBVH16S23D6V + ERLA14DW1	EBVH16S18D6V + ERLA16DW1	EBVH16S23D6V + ERLA16DW1
Heating capacity	Nom.			kW	10.6 (1) / 9.82 (2)		12.0 (1) / 12.5 (2)		16.0 (1) / 16.0 (2)	
Power input	Heating	Nom.		kW	2.18 (1) / 2.68 (2)		2.46 (1) / 3.42 (2)		3.53 (1) / 4.56 (2)	
	Domestic hot water from 10°C to 50°C	Nom.		kWh	2.44	3.41	2.44	3.41	2.44	3.41
Heat up time from 10°C to 50°C				hr	1h15min at 7°C ambient temperature	1h07min at 7°C ambient temperature	1h15min at 7°C ambient temperature	1h07min at 7°C ambient temperature	1h15min at 7°C ambient temperature	1h07min at 7°C ambient temperature
COP					4.83 (1) / 3.66 (2)		4.87 (1) / 3.64 (2)		4.53 (1) / 3.51 (2)	
Pump	Nominal ESP unit	Heating		kPa	46.9 (3) / 48.3 (4)		66.3 (3) / 62.9 (4)		33.7 (3) / 33.7 (4)	
Water side Heat exchanger	Water flow rate	Heating	Nom.	l/min	29.3 (3) / 28.7 (4)		34.7 (3) / 36.1 (4)		46.1 (3) / 46.1 (4)	

2 Specifications

1 - 1 ERLA11-16DW1

Technical specifications			EBVH11S18D6V + ERLA11DW1	EBVH11S23D6V + ERLA11DW1	EBVH16S18D6V + ERLA14DW1	EBVH16S23D6V + ERLA14DW1	EBVH16S18D6V + ERLA16DW1	EBVH16S23D6V + ERLA16DW1			
General	Supplier/ Manu- facturer details	Name and address	Daikin Europe N.V. - Zandvoordestraat 300, 8400 Oostende, Belgium								
		Name or trademark	Daikin Europe N.V.								
	Product descrip- tion	Air-to-water heat pump		Yes							
		Brine-to-water heat pump		No							
		Heat pump combination heater		Yes							
		Low-temperature heat pump		No							
		Supplementary heater integrated		Yes							
	LW(A) Sound power level (according to EN14825)	Indoor	dB(A)	44.0 (5)							
		Outdoor	dB(A)	62.0							
	Sound condition Ecodesign and energy label			Sound power in heating mode, measured according to the EN12102 under conditions of the EN14825							
Space heating general	Air to water unit	Rated airflow (outdoor)	m ³ /h	3,350		4,220		5,100			
		Other	Capacity control	Inverter							
	Pck (Crankcase heater mode) kW	Poff (Off mode)	kW	0.000							
		Psb (Standby mode)	kW	0.023							
		Pto (Thermostat off)	kW	0.023							
		Domestic hot water heating	General	Declared load profile	L	XL	L	XL	L	XL	
Function to fix water heating during off peak hours	No										
Space heating general	Inte- grated supple- mentary heater	Psup	kW	6.0							
		Type of energy input	Electrical								
Domestic hot water heating	Average climate	AEC (Annual electricity consumption)	kWh	886	1,542	886	1,542	886	1,542		
		COPdhw		2.73	2.63	2.73	2.63	2.73	2.63		
		Heat up time		1h 21min	1h 11min	1h 21min	1h 11min	1h 21min	1h 11min		
		Mixed water at 40°C	l	244.0	295.0	244.0	295.0	244.0	295.0		
		η _{wh} (water heating efficiency)	%	116	109	116	109	116	109		
		Qelec (Daily electricity consumption)	kWh	4.260	7.260	4.260	7.260	4.260	7.260		
		Reference hot water temperature	°C	52.7	51.5	52.7	51.5	52.7	51.5		
		Stand-by power input	W	42.0	43.2	42.0	43.2	42.0	43.2		
		Domestic hot water heating	Average climate	Water heating energy efficiency class		A+	A	A+	A	A+	A
				Cold climate	AEC (Annual electricity consumption)	kWh	1,087	1,963	1,087	1,963	1,087
COPdhw					2.24	2.08	2.24	2.08	2.24	2.08	
η _{wh} (water heating efficiency)	%				94	85	94	85	94	85	
Qelec (Daily electricity consumption)	kWh				5.200	9.180	5.200	9.180	5.200	9.180	
Stand-by power input	W		45.9		43.1	45.9	43.1	45.9	43.1		
Warm climate	AEC (Annual electricity consumption)		kWh	737	1,349	737	1,349	737	1,349		
	COPdhw			3.26	3.00	3.26	3.00	3.26	3.00		
	Heat up time			1h 16min	1h 10min	1h 16min	1h 10min	1h 16min	1h 10min		
	Mixed water at 40°C		l	244.0	295.0	244.0	295.0	244.0	295.0		
	η _{wh} (water heating efficiency)	%	139	124	139	124	139	124			
Warm climate	Qelec (Daily electricity consumption)	kWh	3.570	6.350	3.570	6.350	3.570	6.350			
	Reference hot water temperature	°C	52.7	51.5	52.7	51.5	52.7	51.5			
	Stand-by power input	W	38.4	37.6	38.4	37.6	38.4	37.6			

2 Specifications

1 - 1 ERLA11-16DW1

2

Technical specifications				EBVH11S18D6V + ERLA11DW1	EBVH11S23D6V + ERLA11DW1	EBVH16S18D6V + ERLA14DW1	EBVH16S23D6V + ERLA14DW1	EBVH16S18D6V + ERLA16DW1	EBVH16S23D6V + ERLA16DW1	
Space heating	Average climate water outlet 55°C	General	Annual energy consumption	6,397		7,047		7,477		
			ηs (Seasonal space heating efficiency)	126				130		
			Prated at -10°C	kW	10		11		12	
			Qhe Annual energy consumption (GCV)	Gj	23		25		27	
			SCOP		3.23		3.22		3.32	
			Seasonal space heating eff. class				A++			
			A Condition (-7°CDB/-8°CWB)	Cdh (Degradation heating)			1.0			
				COPd	1.89		1.80		1.95	
				Pdh	7.9		8.5		9.4	
				PERd	75.6		72.0		78.0	
			B Condition (2°CDB/-1°CWB)	Cdh (Degradation heating)			1.0			
				COPd	3.25		3.28		3.27	
				Pdh	5.4		6.2		6.9	
				PERd	130.0		131.2		130.8	
			C Condition (7°CDB/6°CWB)	Cdh (Degradation heating)			1.0			
				COPd	4.81		4.88		4.93	
				Pdh			4.4			
				PERd	192.4		195.2		197.2	
			D Condition (12°CDB/11°CWB)	Cdh (Degradation heating)			1.0			
				COPd	6.41		6.58		6.60	
			Pdh			5.3				
			PERd	256.4		263.2		264.0		
		Tol (temperature operating limit)	COPd	1.68		1.76		1.50		

2 Specifications

1 - 1 ERLA11-16DW1

Technical specifications					EBVH11S18D6V + ERLA11DW1	EBVH11S23D6V + ERLA11DW1	EBVH16S18D6V + ERLA14DW1	EBVH16S23D6V + ERLA14DW1	EBVH16S18D6V + ERLA16DW1	EBVH16S23D6V + ERLA16DW1
Space heating 	Average climate water outlet 55°C	Tol (temperature operating limit)	Pdh	kW	6.8		7.0		6.0	
			PERd	%	67.2		70.4		60.0	
			TOL	°C			-10			
			WTOL	°C			55			
		Rated heat output supplementary capacity	Psup (at Tdesign -10°C)	kW	3.2		4.0		6.1	
		Tbiv (bivalent temperature)	COPd		1.96		1.87		2.13	
			Pdh	kW	8.2		8.9		10.1	
			PERd	%	78.4		74.8		85.2	
			Tbiv	°C			-5			
	Cold climate water outlet 55°C	General	Annual energy consumption	kWh	8,082		9,024		9,561	
ηs (Seasonal space heating efficiency)			%	119		117		121		
Prated at -22°C			kW	10		11		12		
Qhe Annual energy consumption (GCV)			Gj	29		32		34		
Warm climate water outlet 55°C	General	Annual energy consumption	kWh	3,258		3,818		3,792		
		ηs (Seasonal space heating efficiency)	%	161		166		168		
		Prated at 2°C	kW	10			12.1			
		Qhe Annual energy consumption (GCV)	Gj	12			14			
	B Condition (2°CDB/1°CWB)	CdH (Degradation heating)	COPd		2.24		2.20		2.17	
			Pdh	kW	9.0		10.1		9.8	
	C Condition (7°CDB/6°CWB)	CdH (Degradation heating)	PERd	%	89.6		88.0		86.8	
							1.0			
	D Condition (12°CDB/11°CWB)	CdH (Degradation heating)	COPd		3.74			3.83		
			Pdh	kW	6.2			7.6		
PERd			%	149.6			153.2			
Average climate water outlet 35°C	General	Annual energy consumption	kWh	4,462		4,935		5,377		
		ηs (Seasonal space heating efficiency)	%	182			181			
		Prated at -10°C	kW	10		11		12		
		Qhe Annual energy consumption (GCV)	Gj	16		18		19		
						4		3		
						2.41		2.65		2.40
				8.5		11.1		11.0		
				96.4		106.0		96.0		

2 Specifications

1 - 1 ERLA11-16DW1

Technical specifications				EBVH11S18D6V + ERLA11DW1	EBVH11S23D6V + ERLA11DW1	EBVH16S18D6V + ERLA14DW1	EBVH16S23D6V + ERLA14DW1	EBVH16S18D6V + ERLA16DW1	EBVH16S23D6V + ERLA16DW1			
Space heating	Average climate water outlet 35°C	General	SCOP	4.63		4.60		4.61				
			Seasonal space heating eff. class	A+++								
			A Condition (7°CDB/48°CWB)	COPd	3.03		2.99		2.87			
			Pdh	kW	9.2		9.8		11.2			
			PERd	%	121.2		119.6		114.8			
			B Condition (2°CDB/11°CWB)	Cdh (Degradation heating)	1.0							
			COPd	4.37		4.35		4.33				
			Pdh	kW	5.5		6.1		6.7			
			PERd	%	174.8		174.0		173.2			
			C Condition (7°CDB/6°CWB)	Cdh (Degradation heating)	1.0							
			COPd	6.74		6.70		6.83				
			Pdh	kW	4.6		4.7					
			PERd	%	269.6		268.0		273.2			
			D Condition (12°CDB/11°CWB)	Cdh (Degradation heating)	1.0							
			COPd	8.54		8.65		8.82				
			Pdh	kW	5.4		5.5					
			PERd	%	341.6		346.0		352.8			
			Tol (temperature operating limit)	COPd	2.73		2.71		2.52			
			Pdh	kW	8.4		9.1		10.6			
			PERd	%	109.2		108.4		100.8			
			TOL	°C	-10							
			WTOL	°C	35							
			Tbiv (bivalent temperature)	COPd	3.01		2.99		2.72			
			Pdh	kW	9.2		9.8		11.4			
PERd	%	120.4		119.6		108.8						
Tbiv	°C	-8		-7		-8						
Rated heat output supplementary capacity	Psup (at Tdesign -10°C)	1.6		1.9		1.4						
Cold climate water outlet 35°C	General	Annual energy consumption	kWh	5,951		6,439		7,257				
		ηs (Seasonal space heating efficiency)	%	163		165		160				
		Prated at -22°C	kW	10		11		12				
		Qhe Annual energy consumption (GCV)	Gj	21		23		26				
		Warm climate water outlet 35°C	General	Annual energy consumption	kWh	2,228		2,431		2,675		
				ηs (Seasonal space heating efficiency)	%	236		239		237		
				Prated at 2°C	kW	10		11		12		
				Qhe Annual energy consumption (GCV)	Gj	8		9		10		
				B Condition	Cdh (Degradation heating)	1.0						
				COPd	3.64		3.51		3.30			
				Pdh	kW	9.8		11.0		11.9		
				PERd	%	145.6		140.4		132.0		
C Condition	Cdh (Degradation heating)			1.0								
COPd	5.70			5.77		5.64						
Pdh	kW			6.7		7.4		8.1				
PERd	%			228.0		230.8		225.6				
Tbiv (bivalent temperature)	COPd	3.81		3.51		3.30						
Pdh	kW	9.2		11.0		11.9						
PERd	%	152.4		140.4		132.0						
Tbiv	°C	3		2		2						
D Condition (12°CDB/11°CWB)	Cdh (Degradation heating)	1.0										
COPd	7.87		7.73		7.73							
Pdh	kW	5.2		5.2		5.2						
PERd	%	314.8		309.2		309.2						

(1)Condition: Ta DB/WB 7°C/6°C - LWC 35°C (DT = 5°C) |

(2)Condition: Ta DB/WB 7°C/6°C - LWC 45°C (DT=5°C) |

(3)Condition 1: cooling Ta 35°C - LWE 18°C (DT = 5°C); heating Ta DB/WB 7°C/6°C - LWC 35°C (DT = 5°C) |

(4)Condition 2: cooling Ta 35°C - LWE 7°C (DT = 5°C); heating Ta DB/WB 7°C/6°C - LWC 45°C (DT = 5°C) |

2 Specifications

1 - 1 ERLA11-16DW1

(5) Measured with a pressure drop of 10 kPa in the heating system at an operating condition of leaving water 47-55°C in a room with an ambient of 20°C. DB/WB 7°C/6°. |
 Cooling: EW 12°C; LW 7°C; ambient conditions: 35°CDB |
 Cooling: EW 23°C; LW 18°C; ambient conditions: 35°CDB |
 According to EN14825

Technical specifications				EBVH11S18D9W + ERLA11DW1	EBVH11S23D9W + ERLA11DW1	EBVH16S18D9W + ERLA14DW1	EBVH16S23D9W + ERLA14DW1	EBVH16S18D9W + ERLA16DW1	EBVH16S23D9W + ERLA16DW1	
Heating capacity	Nom.		kW	10.6 (1) / 9.82 (2)		12.0 (1) / 12.5 (2)		16.0 (1) / 16.0 (2)		
Power input	Heating	Nom.	kW	2.18 (1) / 2.68 (2)		2.46 (1) / 3.42 (2)		3.53 (1) / 4.56 (2)		
	Domestic hot water from 10°C to 50°C	Nom.	kWh	2.44	3.41	2.44	3.41	2.44	3.41	
Heat up time from 10°C to 50°C			hr	1h15min at 7°C ambient temperature	1h07min at 7°C ambient temperature	1h15min at 7°C ambient temperature	1h07min at 7°C ambient temperature	1h15min at 7°C ambient temperature	1h07min at 7°C ambient temperature	
COP				4.83 (1) / 3.66 (2)		4.87 (1) / 3.64 (2)		4.53 (1) / 3.51 (2)		
Pump	Nominal ESP unit	Heating	kPa	46.9 (3) / 48.3 (4)		66.3 (3) / 62.9 (4)		33.7 (3) / 33.7 (4)		
Water side Heat exchanger	Water flow rate	Heating	Nom. l/min	29.3 (3) / 28.7 (4)		34.7 (3) / 36.1 (4)		46.1 (3) / 46.1 (4)		
General	Supplier/Manufacturer details	Daikin Europe N.V. - Zandvoordestraat 300, 8400 Oostende, Belgium Daikin Europe N.V.								
	Product description	Name and address								
		Name or trademark								
		Air-to-water heat pump			Yes					
		Brine-to-water heat pump			No					
		Heat pump combination heater			Yes					
	Low-temperature heat pump			No						
Supplementary heater integrated			Yes							
Water-to-water heat pump			No							
LW(A) Sound power level (according to EN14825)	Indoor		dB(A)	44.0 (5)						
LW(A) Sound power level (according to EN14825)	Outdoor		dB(A)	62.0						
Sound condition				Ecodesign and energy label						
Space heating general	Air to water unit	Rated airflow (outdoor)	m ³ /h	3,350		4,220		5,100		
		Other	Capacity control	Inverter						
	Other	Pck (Crankcase heater mode)	kW	0.000						
		Poff (Off mode)	kW	0.023						
		Psb (Standby mode)	kW	0.023						
		Pto (Thermostat off)	kW	0.023						
Domestic hot water heating	General	Declared load profile		L	XL	L	XL	L	XL	
		Function to fix water heating during off peak hours		No						
Space heating general	Integrated supplementary heater	Psup	kW	9.0						
		Type of energy input		Electrical						
Domestic hot water heating	Average climate	AEC (Annual electricity consumption)	kWh	886	1,542	886	1,542	886	1,542	
		COPdhw		2.73	2.63	2.73	2.63	2.73	2.63	
		Heat up time		1h 21min	1h 11min	1h 21min	1h 11min	1h 21min	1h 11min	
		Mixed water at 40°C	l	244.0	295.0	244.0	295.0	244.0	295.0	
		η _{wh} (water heating efficiency)	%	116	109	116	109	116	109	
		Qelec (Daily electricity consumption)	kWh	4.260	7.260	4.260	7.260	4.260	7.260	
		Reference hot water temperature	°C	52.7	51.5	52.7	51.5	52.7	51.5	
		Stand-by power input	W	42.0	43.2	42.0	43.2	42.0	43.2	

2 Specifications

1 - 1 ERLA11-16DW1

2

Technical specifications			EBVH11S18D9W + ERLA11DW1	EBVH11S23D9W + ERLA11DW1	EBVH16S18D9W + ERLA14DW1	EBVH16S23D9W + ERLA14DW1	EBVH16S18D9W + ERLA16DW1	EBVH16S23D9W + ERLA16DW1	
Domestic hot water heating	Average climate	Water heating energy efficiency class	A+	A	A+	A	A+	A	
	Cold climate	AEC (Annual electricity consumption)	kWh	1,087	1,963	1,087	1,963	1,087	1,963
		COPdhw		2.24	2.08	2.24	2.08	2.24	2.08
		η _{wh} (water heating efficiency)	%	94	85	94	85	94	85
		Qelec (Daily electricity consumption)	kWh	5.200	9.180	5.200	9.180	5.200	9.180
		Stand-by power input	W	45.9	43.1	45.9	43.1	45.9	43.1
	Warm climate	AEC (Annual electricity consumption)	kWh	737	1,349	737	1,349	737	1,349
		COPdhw		3.26	3.00	3.26	3.00	3.26	3.00
		Heat up time		1h 16min	1h 10min	1h 16min	1h 10min	1h 16min	1h 10min
		Mixed water at 40°C	l	244.0	295.0	244.0	295.0	244.0	295.0
		η _{wh} (water heating efficiency)	%	139	124	139	124	139	124
		Qelec (Daily electricity consumption)	kWh	3.570	6.350	3.570	6.350	3.570	6.350
		Reference hot water temperature	°C	52.7	51.5	52.7	51.5	52.7	51.5
		Stand-by power input	W	38.4	37.6	38.4	37.6	38.4	37.6
		Space heating	Average climate water outlet 55°C	General	Annual energy consumption	6,397		7,047	
η _s (Seasonal space heating efficiency)	%			126				130	
	Prated at -10°C			10		11		12	
	Q _{he} Annual energy consumption (GCV)			23		25		27	
	SCOP			3.23		3.22		3.32	
	Seasonal space heating eff. class					A++			
A Condition (-7°CDB/-8°CWB)	Cdh (Degradation heating)					1.0			
	COPd			1.89		1.80		1.95	
	Pdh			7.9		8.5		9.4	
	PERd			75.6		72.0		78.0	
B Condition (2°CDB/1°CWB)	Cdh (Degradation heating)					1.0			
	COPd			3.25		3.28		3.27	
	Pdh			5.4		6.2		6.9	
	PERd			130.0		131.2		130.8	
C Condition (7°CDB/6°CWB)	Cdh (Degradation heating)					1.0			
	COPd			4.81		4.88		4.93	
	Pdh			4.4		4.4		4.4	
	PERd			192.4		195.2		197.2	
D Condition (12°CDB/11°CWB)	Cdh (Degradation heating)					1.0			
	COPd			6.41		6.58		6.60	
	Pdh			5.3		5.3		5.3	
	PERd			256.4		263.2		264.0	
	Tol (temperature operating limit)			COPd		1.68		1.76	

2 Specifications

1 - 1 ERLA11-16DW1

Technical specifications					EBVH11S18D9W + ERLA11DW1	EBVH11S23D9W + ERLA11DW1	EBVH16S18D9W + ERLA14DW1	EBVH16S23D9W + ERLA14DW1	EBVH16S18D9W + ERLA16DW1	EBVH16S23D9W + ERLA16DW1
Space heating 	Average climate water outlet 55°C	Tol (temperature operating limit)	Pdh	kW	6.8		7.0		6.0	
			PERd	%	67.2		70.4		60.0	
			TOL	°C			-10			
			WTOL	°C			55			
		Rated heat output supplementary capacity	Psup (at Tdesign -10°C)	kW	3.2		4.0		6.1	
		Tbiv (bivalent temperature)	COPd		1.96		1.87		2.13	
			Pdh	kW	8.2		8.9		10.1	
			PERd	%	78.4		74.8		85.2	
			Tbiv	°C			-5			
	Cold climate water outlet 55°C	General	Annual energy consumption	kWh	8,082		9,024		9,561	
ηs (Seasonal space heating efficiency)			%	119		117		121		
Prated at -22°C			kW	10		11		12		
Qhe Annual energy consumption (GCV)			Gj	29		32		34		
Warm climate water outlet 55°C	General	Annual energy consumption	kWh	3,258		3,818		3,792		
		ηs (Seasonal space heating efficiency)	%	161		166		168		
		Prated at 2°C	kW	10			12.1			
		Qhe Annual energy consumption (GCV)	Gj	12			14			
	B Condition (2°CDB/1°CWB)	CdH (Degradation heating)	COPd		2.24		2.20		2.17	
			Pdh	kW	9.0		10.1		9.8	
	C Condition (7°CDB/6°CWB)	CdH (Degradation heating)	PERd	%	89.6		88.0		86.8	
							1.0			
	D Condition (12°CDB/11°CWB)	CdH (Degradation heating)	COPd		3.74			3.83		
			Pdh	kW	6.2			7.6		
PERd			%	149.6			153.2			
Tbiv (bivalent temperature)	COPd			5.68		1.0		5.69		
		Pdh	kW			5.0				
		PERd	%	227.2			227.6			
Tbiv (bivalent temperature)	COPd			2.41		2.65		2.40		
		Pdh	kW	8.5		11.1		11.0		
		PERd	%	96.4		106.0		96.0		
Average climate water outlet 35°C	General	Tbiv	°C		4			3		
		Annual energy consumption	kWh	4,462		4,935		5,377		
		ηs (Seasonal space heating efficiency)	%	182			181			
		Prated at -10°C	kW	10		11		12		
	Qhe Annual energy consumption (GCV)	Gj	16		18		19			

2 Specifications

1 - 1 ERLA11-16DW1

Technical specifications				EBVH11S18D9W + ERLA11DW1	EBVH11S23D9W + ERLA11DW1	EBVH16S18D9W + ERLA14DW1	EBVH16S23D9W + ERLA14DW1	EBVH16S18D9W + ERLA16DW1	EBVH16S23D9W + ERLA16DW1	
Space heating	Average climate water outlet 35°C	General	SCOP	4.63		4.60		4.61		
			Seasonal space heating eff. class	A+++						
			A Condition (7°CDB/48°CWB)	COPd	3.03		2.99		2.87	
			Pdh	kW	9.2		9.8		11.2	
			PERd	%	121.2		119.6		114.8	
			B Condition (2°CDB/11°CWB)	Cdh (Degradation heating)			1.0			
			COPd		4.37		4.35		4.33	
			Pdh	kW	5.5		6.1		6.7	
			PERd	%	174.8		174.0		173.2	
			C Condition (7°CDB/6°CWB)	Cdh (Degradation heating)			1.0			
			COPd		6.74		6.70		6.83	
			Pdh	kW		4.6			4.7	
			PERd	%	269.6		268.0		273.2	
			D Condition (12°CDB/11°CWB)	Cdh (Degradation heating)			1.0			
			COPd		8.54		8.65		8.82	
			Pdh	kW		5.4			5.5	
			PERd	%	341.6		346.0		352.8	
			Tol (temperature operating limit)	COPd		2.73		2.71	2.52	
			Pdh	kW		8.4		9.1	10.6	
			PERd	%		109.2		108.4	100.8	
			TOL	°C				-10		
			WTOL	°C				35		
			Tbiv (bivalent temperature)	COPd		3.01		2.99	2.72	
			Pdh	kW		9.2		9.8	11.4	
PERd	%		120.4		119.6	108.8				
Tbiv	°C		-8		-7	-8				
Rated heat output supplementary capacity	Psup (at Tdesign -10°C)	kW	1.6		1.9	1.4				
Cold climate water outlet 35°C	General	Annual energy consumption	kWh	5,951		6,439		7,257		
		ηs (Seasonal space heating efficiency)	%	163		165		160		
		Prated at -22°C	kW	10		11		12		
		Qhe Annual energy consumption (GCV)	Gj	21		23		26		
		Warm climate water outlet 35°C	General	Annual energy consumption	kWh	2,228		2,431		2,675
				ηs (Seasonal space heating efficiency)	%	236		239		237
				Prated at 2°C	kW	10		11		12
				Qhe Annual energy consumption (GCV)	Gj	8		9		10
				B Condition	Cdh (Degradation heating)			1.0		
				COPd		3.64		3.51		3.30
				Pdh	kW	9.8		11.0		11.9
				PERd	%	145.6		140.4		132.0
C Condition	Cdh (Degradation heating)					1.0				
COPd				5.70		5.77		5.64		
Pdh	kW			6.7		7.4		8.1		
PERd	%			228.0		230.8		225.6		
Tbiv (bivalent temperature)	COPd		3.81		3.51	3.30				
Pdh	kW		9.2		11.0	11.9				
PERd	%		152.4		140.4	132.0				
Tbiv	°C		3			2				
D Condition (12°CDB/11°CWB)	Cdh (Degradation heating)			1.0						
COPd		7.87			7.73					
Pdh	kW			5.2						
PERd	%	314.8			309.2					

(1)Condition: Ta DB/WB 7°C/6°C - LWC 35°C (DT = 5°C) |

(2)Condition: Ta DB/WB 7°C/6°C - LWC 45°C (DT=5°C) |

(3)Condition 1: cooling Ta 35°C - LWE 18°C (DT = 5°C); heating Ta DB/WB 7°C/6°C - LWC 35°C (DT = 5°C) |

(4)Condition 2: cooling Ta 35°C - LWE 7°C (DT = 5°C); heating Ta DB/WB 7°C/6°C - LWC 45°C (DT = 5°C) |

2 Specifications

1 - 1 ERLA11-16DW1

(5) Measured with a pressure drop of 10 kPa in the heating system at an operating condition of leaving water 47-55°C in a room with an ambient of 20°C. DB/WB 7°C/6°. |
 Cooling: EW 12°C; LW 7°C; ambient conditions: 35°CDB |
 Cooling: EW 23°C; LW 18°C; ambient conditions: 35°CDB |
 According to EN14825

Technical specifications				EBVX11S18D9W + ERLA11DW1	EBVX11S23D9W + ERLA11DW1	EBVX16S18D9W + ERLA14DW1	EBVX16S23D9W + ERLA14DW1	EBVX16S18D9W + ERLA16DW1	EBVX16S23D9W + ERLA16DW1
SEER				5.92 (5)		5.89 (5)		5.76 (5)	
Heating capacity		Nom.	kW	10.6 (1) / 9.82 (2)		12.0 (1) / 12.5 (2)		16.0 (1) / 16.0 (2)	
Cooling capacity		Nom.	kW	11.2 (3) / 12.0 (4)		13.1 (3) / 13.3 (4)		13.8 (3) / 15.9 (4)	
Power input		Heating	Nom. kW	2.18 (1) / 2.68 (2)		2.46 (1) / 3.42 (2)		3.53 (1) / 4.56 (2)	
		Cooling	Nom. kW	3.43 (3) / 2.52 (4)		4.32 (3) / 2.86 (4)		4.68 (3) / 3.82 (4)	
Domestic hot water from 10°C to 50°C		Nom.	kWh	2.44	3.41	2.44	3.41	2.44	3.41
Heat up time from 10°C to 50°C			hr	1h15min at 7°C ambient temperature	1h07min at 7°C ambient temperature	1h15min at 7°C ambient temperature	1h07min at 7°C ambient temperature	1h15min at 7°C ambient temperature	1h07min at 7°C ambient temperature
COP				4.83 (1) / 3.66 (2)		4.87 (1) / 3.64 (2)		4.53 (1) / 3.51 (2)	
EER				3.26 (3) / 4.75 (4)		3.02 (3) / 4.66 (4)		2.94 (3) / 4.16 (4)	
Pump		Nominal Cooling	kPa	36.2 (6) / 39.6 (7)		59.9 (6) / 60.2 (7)		39.7 (6) / 53.5 (7)	
		ESP unit Heating	kPa	46.9 (6) / 48.3 (7)		66.3 (6) / 62.9 (7)		33.7 (6) / 33.7 (7)	
Water side Heat exchanger		Water flow rate	Cooling Nom. l/min	33.5 (6) / 32.2 (7)		37.3 (6) / 37.2 (7)		44.3 (6) / 39.7 (7)	
			Heating Nom. l/min	29.3 (6) / 28.7 (7)		34.7 (6) / 36.1 (7)		46.1 (6) / 46.1 (7)	
General		Supplier/Manufacturer details	Name and address Name or trademark	Daikin Europe N.V. - Zandvoordestraat 300, 8400 Oostende, Belgium Daikin Europe N.V.					
		Product description	Air-to-water heat pump	Yes					
			Brine-to-water heat pump	No					
			Heat pump combination heater	Yes					
			Low-temperature heat pump	No					
			Supplementary heater integrated	Yes					
			Water-to-water heat pump	No					
LW(A) Sound power level (according to EN14825)		Indoor	dB(A)	44.0 (8)					
LW(A) Sound power level (according to EN14825)		Outdoor	dB(A)	62.0					
Sound condition Ecodesign and energy label				Sound power in heating mode, measured according to the EN12102 under conditions of the EN14825					
Space heating general		Air to water unit	Rated airflow (outdoor) m³/h	3,350		4,220		5,100	
		Other	Capacity control	Inverter					
			Pck (Crankcase heater mode) kW	0.000					
			Poff (Off mode) kW	0.023					
			Psb (Standby mode) kW	0.023					
			Pto (Thermostat off) kW	0.023					
Domestic hot water heating		General	Declared load profile	L	XL	L	XL	L	XL
			Function to fix water heating during off peak hours	No					
Space heating general		Integrated supplementary heater	Psup kW	9.0					
			Type of energy input	Electrical					
Domestic hot water heating		Average climate	AEC (Annual electricity consumption) kWh	886	1,542	886	1,542	886	1,542
			COPdhw	2.73	2.63	2.73	2.63	2.73	2.63

2 Specifications

1 - 1 ERLA11-16DW1

2

Technical specifications			EBVX11S18D9W + ERLA11DW1	EBVX11S23D9W + ERLA11DW1	EBVX16S18D9W + ERLA14DW1	EBVX16S23D9W + ERLA14DW1	EBVX16S18D9W + ERLA16DW1	EBVX16S23D9W + ERLA16DW1	
Domestic hot water heating	Average climate	Heat up time	1h 21min	1h 11min	1h 21min	1h 11min	1h 21min	1h 11min	
		Mixed water at 40°C	l	244.0	295.0	244.0	295.0	244.0	295.0
		η _{wh} (water heating efficiency)	%	116	109	116	109	116	109
		Qelec (Daily electricity consumption)	kWh	4.260	7.260	4.260	7.260	4.260	7.260
		Reference hot water temperature	°C	52.7	51.5	52.7	51.5	52.7	51.5
		Stand-by power input	W	42.0	43.2	42.0	43.2	42.0	43.2
		Water heating energy efficiency class		A+	A	A+	A	A+	A
		Cold climate	AEC (Annual electricity consumption)	kWh	1,087	1,963	1,087	1,963	1,087
	COP _{dhw}			2.24	2.08	2.24	2.08	2.24	2.08
	η _{wh} (water heating efficiency)		%	94	85	94	85	94	85
	Qelec (Daily electricity consumption)		kWh	5.200	9.180	5.200	9.180	5.200	9.180
	Warm climate	Stand-by power input	W	45.9	43.1	45.9	43.1	45.9	43.1
		AEC (Annual electricity consumption)	kWh	737	1,349	737	1,349	737	1,349
		COP _{dhw}		3.26	3.00	3.26	3.00	3.26	3.00
		Heat up time		1h 16min	1h 10min	1h 16min	1h 10min	1h 16min	1h 10min
		Mixed water at 40°C	l	244.0	295.0	244.0	295.0	244.0	295.0
η _{wh} (water heating efficiency)		%	139	124	139	124	139	124	
Qelec (Daily electricity consumption)		kWh	3.570	6.350	3.570	6.350	3.570	6.350	
Reference hot water temperature		°C	52.7	51.5	52.7	51.5	52.7	51.5	
Stand-by power input	W	38.4	37.6	38.4	37.6	38.4	37.6		
Space heating	Average climate water outlet 55°C	General	Annual energy consumption	kWh	6,312		6,962		7,392
			η _s (Seasonal space heating efficiency)	%	128				131
		Prated at -10°C	Q _{he} Annual energy consumption (GCV)	Gj	23		25		27
			SCOP		3.27		3.26		3.35
		Seasonal space heating eff. class				A++			
		A Condition (-7°CDB/-8°CWB)	Cdh (Degradation heating)				1.0		
			COPd		1.89		1.80		1.95
			Pdh	kW	7.9		8.5		9.4
		B Condition (2°CDB/1°CWB)	PERd	%	75.6		72.0		78.0
			Cdh (Degradation heating)				1.0		
			COPd		3.25		3.28		3.27
		Pdh	kW	5.4		6.2		6.9	
			PERd	%	130.0		131.2		130.8
		C Condition (7°CDB/6°CWB)	Cdh (Degradation heating)				1.0		
			COPd		4.81		4.88		4.93
Pdh	kW				4.4				

2 Specifications

1 - 1 ERLA11-16DW1

Technical specifications				EBVX11S18D9W + ERLA11DW1	EBVX11S23D9W + ERLA11DW1	EBVX16S18D9W + ERLA14DW1	EBVX16S23D9W + ERLA14DW1	EBVX16S18D9W + ERLA16DW1	EBVX16S23D9W + ERLA16DW1	
Space heating 	Average climate water outlet 55°C	C Condition (7°CDB/6°CWB)	PERd	%	192.4		195.2		197.2	
			D Condition (12°CDB/11°CWB)		Cd _h (Degradation heating)		1.0			
				COP _d		6.41		6.58		6.60
				Pd _h	kW			5.3		
				PERd	%	256.4		263.2		264.0
		Tol (temperature operating limit)		COP _d		1.68		1.76		1.50
				Pd _h	kW	6.8		7.0		6.0
				PERd	%	67.2		70.4		60.0
				TOL	°C			-10		
				WTOL	°C			55		
	Rated heat output supplementary capacity		P _{sup} (at T _{design} -10°C)	kW	3.2		4.0		6.1	
	T _{biv} (bivalent temperature)		COP _d		1.96		1.87		2.13	
			Pd _h	kW	8.2		8.9		10.1	
			PERd	%	78.4		74.8		85.2	
			T _{biv}	°C			-5			
	Cold climate water outlet 55°C	General	Annual energy consumption	kWh	8,031		8,974		9,510	
			η _s (Seasonal space heating efficiency)	%	120		118		121	
			Prated at -22°C	kW	10		11		12	
			Q _{he} Annual energy consumption (GCV)	Gj	29		32		34	
			Warm climate water outlet 55°C		General	Annual energy consumption	kWh	3,157		3,717
		η _s (Seasonal space heating efficiency)	%	166		171		172		
		Prated at 2°C	kW	10			12.1			
		Q _{he} Annual energy consumption (GCV)	Gj	11			13			
B Condition (2°CDB/1°CWB)		Cd _h (Degradation heating)				1.0				
		COP _d		2.24		2.20		2.17		
		Pd _h	kW	9.0		10.1		9.8		
		PERd	%	89.6		88.0		86.8		
C Condition (7°CDB/6°CWB)		Cd _h (Degradation heating)				1.0				
		COP _d		3.74			3.83			
		Pd _h	kW	6.2			7.6			
		PERd	%	149.6			153.2			
D Condition (12°CDB/11°CWB)		Cd _h (Degradation heating)				1.0				
		COP _d		5.68			5.69			
		Pd _h	kW			5.0				
		PERd	%	227.2			227.6			
T _{biv} (bivalent temperature)		COP _d		2.41		2.65		2.40		
		Pd _h	kW	8.5		11.1		11.0		

2 Specifications

1 - 1 ERLA11-16DW1

2

Technical specifications					EBVX11S18D9W + ERLA11DW1	EBVX11S23D9W + ERLA11DW1	EBVX16S18D9W + ERLA14DW1	EBVX16S23D9W + ERLA14DW1	EBVX16S18D9W + ERLA16DW1	EBVX16S23D9W + ERLA16DW1
Space heating	Warm climate water outlet 55°C	Tbiv	PERd	%	96.4			106.0		96.0
		(bivalent temperature)	Tbiv	°C		4				3
Average climate water outlet 35°C	General	Annual energy consumption	kWh		4,378		4,851		5,293	
		ηs (Seasonal space heating efficiency)	%		186		184			
		Prated at -10°C	kW		10		11		12	
		Qhe Annual energy consumption (GCV)	Gj		16		17		19	
		SCOP			4.72		4.68			
		Seasonal space heating eff. class					A+++			
		A Condition (-7°CDB/-8°CWB)	COPd		3.03		2.99		2.87	
			Pdh	kW	9.2		9.8		11.2	
			PERd	%	121.2		119.6		114.8	
			Cdh (Degradation heating)				1.0			
B Condition (2°CDB/1°CWB)	COPd		4.37		4.35		4.33			
	Pdh	kW	5.5		6.1		6.7			
	PERd	%	174.8		174.0		173.2			
C Condition (7°CDB/6°CWB)	Cdh (Degradation heating)				1.0					
	COPd		6.74		6.70		6.83			
	Pdh	kW		4.6		4.7				
D Condition (12°CDB/11°CWB)	PERd	%	269.6		268.0		273.2			
	Cdh (Degradation heating)				1.0					
	COPd		8.54		8.65		8.82			
Tol (temperature operating limit)	Pdh	kW		5.4		5.5				
	PERd	%	341.6		346.0		352.8			
	COPd		2.73		2.71		2.52			
	Pdh	kW	8.4		9.1		10.6			
Tbiv (bivalent temperature)	PERd	%	109.2		108.4		100.8			
	TOL	°C			-10					
Rated heat output supplementary capacity	WTOL	°C			35					
	COPd		3.01		2.99		2.72			
	Pdh	kW	9.2		9.8		11.4			
	PERd	%	120.4		119.6		108.8			
	Tbiv	°C	-8		-7		-8			
	Psup (at Tdesign -10°C)	kW	1.6		1.9		1.4			
Cold climate water outlet 35°C	General	Annual energy consumption	kWh	5,901		6,388		7,206		
		ηs (Seasonal space heating efficiency)	%	164		167		161		
		Prated at -22°C	kW	10		11		12		
		Qhe Annual energy consumption (GCV)	Gj	21		23		26		

2 Specifications

1 - 1 ERLA11-16DW1

Technical specifications				EBVX11S18D9W + ERLA11DW1	EBVX11S23D9W + ERLA11DW1	EBVX16S18D9W + ERLA14DW1	EBVX16S23D9W + ERLA14DW1	EBVX16S18D9W + ERLA16DW1	EBVX16S23D9W + ERLA16DW1		
Space heating 	Warm climate water outlet 35°C	General	Annual energy consumption	kWh	2,126		2,330		2,573		
			ηs (Seasonal space heating efficiency)	%	248		249		246		
			Prated at 2°C	kW	10		11		12		
			Qhe Annual energy consumption (GCV)	Gj		8			9		
			B Condition (2°CDB/B/1°CWB)	CdH (Degradation heating)	COPd		3.64		3.51		3.30
					Pdh	kW	9.8		11.0		11.9
					PERd	%	145.6		140.4		132.0
			C Condition (7°CDB/B/6°CWB)	CdH (Degradation heating)	COPd		5.70		5.77		5.64
					Pdh	kW	6.7		7.4		8.1
					PERd	%	228.0		230.8		225.6
			Tbiv (bivalent temperature)	COPd	COPd		3.81		3.51		3.30
					Pdh	kW	9.2		11.0		11.9
					PERd	%	152.4		140.4		132.0
			D Condition (12°CDB/11°CWB)	CdH (Degradation heating)	COPd				1.0		7.73
					Pdh	kW			5.2		
					PERd	%		314.8		309.2	

(1)Condition: Ta DB/WB 7°C/6°C - LWC 35°C (DT = 5°C) |

(2)Condition: Ta DB/WB 7°C/6°C - LWC 45°C (DT=5°C) |

(3)Cooling: EW 12°C; LW 7°C; ambient conditions: 35°CDB |

(4)Cooling: EW 23°C; LW 18°C; ambient conditions: 35°CDB |

(5)According to EN14825 |

(6)Condition 1: cooling Ta 35°C - LWE 18°C (DT = 5°C); heating Ta DB/WB 7°C/6°C - LWC 35°C (DT = 5°C) |

(7)Condition 2: cooling Ta 35°C - LWE 7°C (DT = 5°C); heating Ta DB/WB 7°C/6°C - LWC 45°C (DT = 5°C) |

(8)Measured with a pressure drop of 10 kPa in the heating system at an operating condition of leaving water 47-55°C in a room with an ambient of 20°C. DB/WB 7°C/6°.

Technical specifications				EBVZ16S18D6V + ERLA11DW1	EBVZ16S23D6V + ERLA11DW1	EBVZ16S18D6V + ERLA14DW1	EBVZ16S23D6V + ERLA14DW1	EBVZ16S18D6V + ERLA16DW1	EBVZ16S23D6V + ERLA16DW1	
Heating capacity	Nom.		kW	10.6 (1) / 9.82 (2)		12.0 (1) / 12.5 (2)		16.0 (1) / 16.0 (2)		
Power input	Heating	Nom.	kW	2.18 (1) / 2.68 (2)		2.46 (1) / 3.42 (2)		3.53 (1) / 4.56 (2)		
	Domestic hot water from 10°C to 50°C	Nom.	kWh	2.44	3.41	2.44	3.41	2.44	3.41	
Heat up time from 10°C to 50°C			hr	1h15min at 7°C ambient temperature	1h07min at 7°C ambient temperature	1h15min at 7°C ambient temperature	1h07min at 7°C ambient temperature	1h15min at 7°C ambient temperature		
COP				4.83 (1) / 3.66 (2)		4.87 (1) / 3.64 (2)		4.53 (1) / 3.51 (2)		
General	Supplier/Manufacturer details	Name and address		Daikin Europe N.V. - Zandvoordestraat 300, 8400 Oostende, Belgium						
		Name or trademark		Daikin Europe N.V.						
	Product description	Air-to-water heat pump			Yes					
		Brine-to-water heat pump			No					
		Heat pump combination heater			Yes					
		Low-temperature heat pump			No					
		Supplementary heater integrated			Yes					
	Water-to-water heat pump			No						
LW(A) Sound power level (according to EN14825)	Indoor		dB(A)	44.0 (3)						
LW(A) Sound power level (according to EN14825)	Outdoor		dB(A)	62.0						
Sound condition Ecodesign and energy label				Sound power in heating mode, measured according to the EN12102 under conditions of the EN14825						
Space heating general	Air to water unit	Rated airflow (outdoor)	m³/h	3,350		4,220		5,100		
	Other	Capacity control			Inverter					
		Pck (Crankcase heater mode)		kW	0.000					
		Poff (Off mode)		kW	0.023					
		Psb (Standby mode)		kW	0.023					
		Pto (Thermostat off)		kW	0.023					

2 Specifications

1 - 1 ERLA11-16DW1

2

Technical specifications			EBVZ16S18D6V + ERLA11DW1	EBVZ16S23D6V + ERLA11DW1	EBVZ16S18D6V + ERLA14DW1	EBVZ16S23D6V + ERLA14DW1	EBVZ16S18D6V + ERLA16DW1	EBVZ16S23D6V + ERLA16DW1		
Domestic hot water heating	General	Declared load profile	L	XL	L	XL	L	XL		
		Function to fix water heating during off peak hours	No							
Space heating general	Inte- grated supple- mentary heater	Psup kW	6.0							
		Type of energy input	Electrical							
Domestic hot water heating	Average climate	AEC (Annual electricity consumption) kWh	886	1,542	886	1,542	886	1,542		
		COPdhw	2.73	2.63	2.73	2.63	2.73	2.63		
		Heat up time	1h 21min	1h 11min	1h 21min	1h 11min	1h 21min	1h 11min		
		Mixed water at 40°C l	244.0	295.0	244.0	295.0	244.0	295.0		
		ηwh (water heating efficiency) %	116	109	116	109	116	109		
		Qelec (Daily electricity consumption) kWh	4.260	7.260	4.260	7.260	4.260	7.260		
		Reference hot water temperature °C	52.7	51.5	52.7	51.5	52.7	51.5		
		Stand-by power input W	42.0	43.2	42.0	43.2	42.0	43.2		
		Water heating energy efficiency class	A+	A	A+	A	A+	A		
		Cold climate	AEC (Annual electricity consumption) kWh	1,087	1,963	1,087	1,963	1,087	1,963	
			COPdhw	2.24	2.08	2.24	2.08	2.24	2.08	
		Domestic hot water heating	Cold climate	ηwh (water heating efficiency) %	94	85	94	85	94	85
				Qelec (Daily electricity consumption) kWh	5.200	9.180	5.200	9.180	5.200	9.180
Stand-by power input W	45.9			43.1	45.9	43.1	45.9	43.1		
Warm climate	AEC (Annual electricity consumption) kWh			737	1,349	737	1,349	737	1,349	
	COPdhw			3.26	3.00	3.26	3.00	3.26	3.00	
	Heat up time		1h 16min	1h 10min	1h 16min	1h 10min	1h 16min	1h 10min		
	Mixed water at 40°C l		244.0	295.0	244.0	295.0	244.0	295.0		
	ηwh (water heating efficiency) %		139	124	139	124	139	124		
Warm climate	Qelec (Daily electricity consumption) kWh		3.570	6.350	3.570	6.350	3.570	6.350		
	Reference hot water temperature °C		52.7	51.5	52.7	51.5	52.7	51.5		
	Stand-by power input W	38.4	37.6	38.4	37.6	38.4	37.6			

2 Specifications

1 - 1 ERLA11-16DW1

Technical specifications				EBVZ16S18D6V + ERLA11DW1	EBVZ16S23D6V + ERLA11DW1	EBVZ16S18D6V + ERLA14DW1	EBVZ16S23D6V + ERLA14DW1	EBVZ16S18D6V + ERLA16DW1	EBVZ16S23D6V + ERLA16DW1			
Space heating Average climate water outlet 55°C	General	Annual energy consumption	kWh	6,405		7,047		7,477				
		ηs (Seasonal space heating efficiency)	%	131		126		130				
		Prated at -10°C	kW	10		11		12				
		Qhe Annual energy consumption (GCV)	Gj	23		25		27				
		SCOP		3.23		3.22		3.32				
		Seasonal space heating eff. class		A++								
		A Condition (-7°CDB/-8°CWB)	Cdh (Degradation heating)		1.0							
			COPd		1.89		1.80		1.95			
			Pdh	kW	7.9		8.5		9.4			
			PERd	%	75.6		72.0		78.0			
		B Condition (2°CDB/-1°CWB)	Cdh (Degradation heating)		1.0							
			COPd		3.25		3.28		3.27			
			Pdh	kW	5.4		6.2		6.9			
			PERd	%	130.0		131.2		130.8			
		C Condition (7°CDB/6°CWB)	Cdh (Degradation heating)		1.0							
			COPd		4.79		4.88		4.93			
			Pdh	kW	4.4		4.4		4.4			
			PERd	%	191.6		195.2		197.2			
		D Condition (12°CDB/11°CWB)	Cdh (Degradation heating)		1.0							
			COPd		6.38		6.58		6.60			
	Pdh	kW	5.3		5.3		5.3					
	PERd	%	255.2		263.2		264.0					
Tol (temperature operating limit)	COPd		1.68		1.76		1.50					
	Pdh	kW	6.9		7.0		6.0					
	PERd	%	67.2		70.4		60.0					

2 Specifications

1 - 1 ERLA11-16DW1

2

Technical specifications				EBVZ16S18D6V + ERLA11DW1	EBVZ16S23D6V + ERLA11DW1	EBVZ16S18D6V + ERLA14DW1	EBVZ16S23D6V + ERLA14DW1	EBVZ16S18D6V + ERLA16DW1	EBVZ16S23D6V + ERLA16DW1
Space heating	Average climate water outlet 55°C	Tol (temperature operating limit)	TOL °C					-10	
			WTOL °C					55	
	Rated heat output supplementary capacity	Psup (at Tdesign -10°C)	kW	3.2		4.0			6.1
		Tbiv (bivalent temperature)	COPd	1.96		1.87			2.13
		Pdh	kW	8.2		8.9			10.1
		PERd	%	78.4		74.8			85.2
	Cold climate water outlet 55°C	General	Annual energy consumption	kWh	8,083		9,024		9,561
			ηs (Seasonal space heating efficiency)	%	119		117		121
			Prated at -22°C	kW	10		11		12
			Qhe Annual energy consumption (GCV)	Gj	29		32		34
Warm climate water outlet 55°C	General	Annual energy consumption	kWh	3,262		3,818		3,792	
		ηs (Seasonal space heating efficiency)	%	161		166		168	
		Prated at 2°C	kW	10			12.1		
		Qhe Annual energy consumption (GCV)	Gj	12			14		
B Condition (2°CDB/1°CWB)	Condition	Cdh (Degradation heating)				1.0			
		COPd		2.23		2.20		2.17	
		Pdh	kW	9.0		10.1		9.8	
C Condition (7°CDB/6°CWB)	Condition	PERd	%	89.2		88.0		86.8	
		Cdh (Degradation heating)				1.0			
		COPd		3.74			3.83		
D Condition (12°CDB/11°CWB)	Condition	Pdh	kW	6.2			7.6		
		PERd	%	149.6			153.2		
		Cdh (Degradation heating)				1.0			
Tbiv (bivalent temperature)	Tbiv	COPd		5.67			5.69		
		Pdh	kW			5.0			
		PERd	%	226.8			227.6		
Average climate water outlet 35°C	General	COPd		2.40		2.65		2.40	
		Pdh	kW	8.5		11.1		11.0	
		PERd	%	96.0		106.0		96.0	
		Tbiv	°C		4			3	
Average climate water outlet 35°C	General	Annual energy consumption	kWh	4,479		4,935		5,377	
		ηs (Seasonal space heating efficiency)	%	182			181		
		Prated at -10°C	kW	10		11		12	
		Qhe Annual energy consumption (GCV)	Gj	16		18		19	
		SCOP		4.61		4.60		4.61	
	Seasonal space heating eff. class					A+++			

2 Specifications

1 - 1 ERLA11-16DW1

Technical specifications				EBVZ16S18D6V + ERLA11DW1	EBVZ16S23D6V + ERLA11DW1	EBVZ16S18D6V + ERLA14DW1	EBVZ16S23D6V + ERLA14DW1	EBVZ16S18D6V + ERLA16DW1	EBVZ16S23D6V + ERLA16DW1	
Space heating 	Average climate water outlet 35°C	A Condition (7°CDB/-8°CWB)	COPd	3.03		2.99		2.87		
			Pdh kW	9.2		9.8		11.2		
			PERd %	121.2		119.6		114.8		
		B Condition (2°CDB/-B/1°CWB)	Cdh (Degradation heating)			4.35			4.33	
			COPd		5.5		6.1		6.7	
			PERd %		174.0				173.2	
		C Condition (7°CDB/-B/6°CWB)	Cdh (Degradation heating)				1.0			
			COPd		6.69		6.70		6.83	
			Pdh kW			4.6			4.7	
		D Condition (12°CDB/11°CWB)	Cdh (Degradation heating)				1.0			
	COPd			8.47		8.65		8.82		
	Pdh kW				5.4			5.5		
	Tol (temperature operating limit)	PERd %		338.8		346.0		352.8		
		COPd		2.72		2.71		2.52		
		Pdh kW		8.4		9.1		10.6		
		PERd %		108.8		108.4		100.8		
		TOL °C				-10				
	Tbiv (bivalent temperature)	WTOL °C				35				
		COPd		3.01		2.99		2.72		
		Pdh kW		9.2		9.8		11.4		
		PERd %		120.4		119.6		108.8		
		Tbiv °C		-8		-7		-8		
	Rated heat output supplementary capacity	Psup (at Tdesign -10°C) kW		1.6		1.9		1.4		
	Cold climate water outlet 35°C	General	Annual energy consumption kWh	5,964		6,439		7,257		
			ηs (Seasonal space heating efficiency) %	162		165		160		
Prated at -22°C kW			12		11		12			
Qhe Annual energy consumption (GCV) GJ			21		23		26			
Warm climate water outlet 35°C	General	Annual energy consumption kWh	2,228		2,431		2,675			
		ηs (Seasonal space heating efficiency) %	237		239		237			
		Prated at 2°C kW	12		11		12			
		Qhe Annual energy consumption (GCV) GJ	8		9		10			
B Condition (2°CDB/-B/1°CWB)	Cdh (Degradation heating)				1.0					
	COPd		3.80		3.51		3.30			
	Pdh kW		9.2		11.0		11.9			
C Condition (7°CDB/-B/6°CWB)	PERd %		152.0		140.4		132.0			
	Cdh (Degradation heating)				1.0					
	COPd		5.70		5.77		5.64			
D Condition (12°CDB/11°CWB)	Pdh kW		6.7		7.4		8.1			
	PERd %		228.0		230.8		225.6			
	Tbiv COPd		3.80		3.51		3.30			
Tbiv (bivalent temperature)	Pdh kW		9.2		11.0		11.9			
	PERd %		152.0		140.4		132.0			
	Tbiv °C		3			2				
D Condition (12°CDB/11°CWB)	Cdh (Degradation heating)				1.0					
	COPd		7.87			7.73				
	Pdh kW				5.2					
PERd %			314.8			309.2				

(1)Condition: Ta DB/WB 7°C/6°C - LWC 35°C (DT = 5°C) |

(2)Condition: Ta DB/WB 7°C/6°C - LWC 45°C (DT=5°C) |

(3)Measured with a pressure drop of 10 kPa in the heating system at an operating condition of leaving water 47-55°C in a room with an ambient of 20°C. DB/WB 7°C/6°C. |

Cooling: EW 12°C; LW 7°C; ambient conditions: 35°CDB |

Cooling: EW 23°C; LW 18°C; ambient conditions: 35°CDB |

According to EN14825 |

Condition 1: cooling Ta 35°C - LWE 18°C (DT = 5°C); heating Ta DB/WB 7°C/6°C - LWC 35°C (DT = 5°C) |

Condition 2: cooling Ta 35°C - LWE 7°C (DT = 5°C); heating Ta DB/WB 7°C/6°C - LWC 45°C (DT = 5°C) |

2 Specifications

1 - 1 ERLA11-16DW1

2

Technical specifications			EBVZ16S18D9W + ERLA11DW1	EBVZ16S23D9W + ERLA11DW1	EBVZ16S18D9W + ERLA14DW1	EBVZ16S23D9W + ERLA14DW1	EBVZ16S18D9W + ERLA16DW1	EBVZ16S23D9W + ERLA16DW1		
Heating capacity	Nom.	kW	10.6 (1) / 9.82 (2)		12.0 (1) / 12.5 (2)		16.0 (1) / 16.0 (2)			
Power input	Heating	Nom. kW	2.18 (1) / 2.68 (2)		2.46 (1) / 3.42 (2)		3.53 (1) / 4.56 (2)			
	Domestic hot water from 10°C to 50°C	Nom. kWh	2.44	3.41	2.44	3.41	2.44	3.41		
Heat up time from 10°C to 50°C		hr	1h15min at 7°C ambient temperature	1h07min at 7°C ambient temperature	1h15min at 7°C ambient temperature	1h07min at 7°C ambient temperature	1h15min at 7°C ambient temperature			
COP			4.83 (1) / 3.66 (2)		4.87 (1) / 3.64 (2)		4.53 (1) / 3.51 (2)			
General	Supplier/Manufacturer details	Name and address	Daikin Europe N.V. - Zandvoordestraat 300, 8400 Oostende, Belgium							
		Name or trademark	Daikin Europe N.V.							
	Product description	Air-to-water heat pump		Yes						
		Brine-to-water heat pump		No						
		Heat pump combination heater		Yes						
		Low-temperature heat pump		No						
		Supplementary heater integrated		Yes						
Water-to-water heat pump		No								
LW(A) Sound power level (according to EN14825)	Indoor	dB(A)	44.0 (3)							
LW(A) Sound power level (according to EN14825)	Outdoor	dB(A)	62.0							
Sound condition	Ecodesign and energy label		Sound power in heating mode, measured according to the EN12102 under conditions of the EN14825							
Space heating general	Air to water unit	Rated airflow (outdoor)	m ³ /h		3,350		4,220		5,100	
		Other	Capacity control	Inverter						
		Pck (Crankcase heater mode)	kW	0.000						
		Poff (Off mode)	kW	0.023						
		Psb (Standby mode)	kW	0.023						
	Pto (Thermostat off)	kW	0.023							
Domestic hot water heating	General	Declared load profile	L	XL	L	XL	L	XL		
		Function to fix water heating during off peak hours	No							
Space heating general	Integrated supplementary heater	Psup	kW		9.0					
		Type of energy input	Electrical							
Domestic hot water heating	Average climate	AEC (Annual electricity consumption)	kWh	886	1,542	886	1,542	886	1,542	
		COPdhw		2.73	2.63	2.73	2.63	2.73	2.63	
		Heat up time		1h 21min	1h 11min	1h 21min	1h 11min	1h 21min	1h 11min	
		Mixed water at 40°C	l	244.0	295.0	244.0	295.0	244.0	295.0	
		η _{wh} (water heating efficiency)	%	116	109	116	109	116	109	
		Qelec (Daily electricity consumption)	kWh	4.260	7.260	4.260	7.260	4.260	7.260	
		Reference hot water temperature	°C	52.7	51.5	52.7	51.5	52.7	51.5	
		Stand-by power input	W	42.0	43.2	42.0	43.2	42.0	43.2	
		Water heating energy efficiency class		A+	A	A+	A	A+	A	
		Cold climate	AEC (Annual electricity consumption)	kWh	1,087	1,963	1,087	1,963	1,087	1,963

2 Specifications

1 - 1 ERLA11-16DW1

Technical specifications			EBVZ16S18D9W + ERLA11DW1	EBVZ16S23D9W + ERLA11DW1	EBVZ16S18D9W + ERLA14DW1	EBVZ16S23D9W + ERLA14DW1	EBVZ16S18D9W + ERLA16DW1	EBVZ16S23D9W + ERLA16DW1		
Domestic hot water heating	Cold climate	COPdhw	2.24	2.08	2.24	2.08	2.24	2.08		
		η _{wh} (water heating efficiency)	%	94	85	94	85	94	85	
		Q _{elec} (Daily electricity consumption)	kWh	5.200	9.180	5.200	9.180	5.200	9.180	
		Stand-by power input	W	45.9	43.1	45.9	43.1	45.9	43.1	
		Warm climate	AEC (Annual electricity consumption)	kWh	737	1,349	737	1,349	737	1,349
			COPdhw		3.26	3.00	3.26	3.00	3.26	3.00
	Heat up time			1h 16min	1h 10min	1h 16min	1h 10min	1h 16min	1h 10min	
	Mixed water at 40°C		l	244.0	295.0	244.0	295.0	244.0	295.0	
	η _{wh} (water heating efficiency)		%	139	124	139	124	139	124	
	Q _{elec} (Daily electricity consumption)		kWh	3.570	6.350	3.570	6.350	3.570	6.350	
	Reference hot water temperature	°C	52.7	51.5	52.7	51.5	52.7	51.5		
	Stand-by power input	W	38.4	37.6	38.4	37.6	38.4	37.6		
Space heating	Average climate water outlet 55°C	General	Annual energy consumption	kWh	6,405		7,047			
		η _s (Seasonal space heating efficiency)	%	131		126		130		
		Prated at -10°C	kW	10		11		12		
		Q _{he} Annual energy consumption (GCV)	Gj	23		25		27		
		SCOP		3.23		3.22		3.32		
		Seasonal space heating eff. class				A++				
		A Condition (7°CDB/-8°CWB)	Cdh (Degradation heating)				1.0			
			COPd		1.89		1.80		1.95	
			Pdh	kW	7.9		8.5		9.4	
		B Condition (2°CDB/1°CWB)	Cdh (Degradation heating)				1.0			
	COPd			3.25		3.28		3.27		
	Pdh		kW	5.4		6.2		6.9		
	C Condition (7°CDB/6°CWB)	Cdh (Degradation heating)				1.0				
		COPd		4.79		4.88		4.93		
		Pdh	kW	191.6		195.2		197.2		
	D Condition (12°CDB/11°CWB)	Cdh (Degradation heating)				1.0				
		COPd		6.38		6.58		6.60		
		Pdh	kW	255.2		263.2		264.0		
	Tol (temperature operating limit)	COPd		1.68		1.76		1.50		
		Pdh	kW	6.9		7.0		6.0		
		PERd	%	67.2		70.4		60.0		

2 Specifications



1 - 1 ERLA11-16DW1

2

Technical specifications				EBVZ16S18D9W + ERLA11DW1	EBVZ16S23D9W + ERLA11DW1	EBVZ16S18D9W + ERLA14DW1	EBVZ16S23D9W + ERLA14DW1	EBVZ16S18D9W + ERLA16DW1	EBVZ16S23D9W + ERLA16DW1
Space heating	Average climate water outlet 55°C	Tol (temperature operating limit)	TOL °C					-10	
			WTOL °C					55	
	Rated heat output supplementary capacity	Psup (at Tdesign -10°C)	kW	3.2		4.0			6.1
		Tbiv (bivalent temperature)	COPd	1.96		1.87			2.13
		Pdh	kW	8.2		8.9			10.1
		PERd	%	78.4		74.8			85.2
	Cold climate water outlet 55°C	General	Annual energy consumption	kWh	8,083		9,024		9,561
			ηs (Seasonal space heating efficiency)	%	119		117		121
			Prated at -22°C	kW	10		11		12
			Qhe Annual energy consumption (GCV)	Gj	29		32		34
Warm climate water outlet 55°C	General	Annual energy consumption	kWh	3,262		3,818		3,792	
		ηs (Seasonal space heating efficiency)	%	161		166		168	
		Prated at 2°C	kW	10			12.1		
		Qhe Annual energy consumption (GCV)	Gj	12			14		
	B Condition (2°CDB/1°CWB)	Cd	Cdh (Degradation heating)				1.0		
			COPd		2.23		2.20		2.17
		Pd	Pdh	kW	9.0		10.1		9.8
			PERd	%	89.2		88.0		86.8
	C Condition (7°CDB/6°CWB)	Cd	Cdh (Degradation heating)				1.0		
			COPd		3.74		3.83		
Pdh			kW	6.2		7.6			
PERd			%	149.6		153.2			
D Condition (12°CDB/11°CWB)	Cd	Cdh (Degradation heating)				1.0			
		COPd		5.67		5.69			
		Pdh	kW			5.0			
Tbiv (bivalent temperature)	COPd			226.8		227.6			
				2.40		2.65		2.40	
				8.5		11.1		11.0	
				96.0		106.0		96.0	
Average climate water outlet 35°C	General	Tbiv	°C		4			3	
		Annual energy consumption	kWh	4,479		4,935		5,377	
		ηs (Seasonal space heating efficiency)	%	182			181		
		Prated at -10°C	kW	10		11		12	
		Qhe Annual energy consumption (GCV)	Gj	16		18		19	
		SCOP		4.61		4.60		4.61	
		Seasonal space heating eff. class				A+++			

2 Specifications

1 - 1 ERLA11-16DW1

Technical specifications				EBVZ16S18D9W + ERLA11DW1	EBVZ16S23D9W + ERLA11DW1	EBVZ16S18D9W + ERLA14DW1	EBVZ16S23D9W + ERLA14DW1	EBVZ16S18D9W + ERLA16DW1	EBVZ16S23D9W + ERLA16DW1	
Space heating 	Average climate water outlet 35°C	A Condition (7°CDB/-8°CWB)	COPd	3.03		2.99		2.87		
			Pdh kW	9.2		9.8		11.2		
			PERd %	121.2		119.6		114.8		
		B Condition (2°CDB/-B/1°CWB)	Cdh (Degradation heating)			4.35			4.33	
			COPd		5.5		6.1		6.7	
			PERd %		174.0				173.2	
		C Condition (7°CDB/-B/6°CWB)	Cdh (Degradation heating)				1.0			
			COPd		6.69		6.70		6.83	
			Pdh kW			4.6			4.7	
		D Condition (12°CDB/11°CWB)	Cdh (Degradation heating)				1.0			
			COPd		8.47		8.65		8.82	
			Pdh kW			5.4			5.5	
	Tol (temperature operating limit)	PERd %		338.8		346.0		352.8		
		COPd		2.72		2.71		2.52		
		Pdh kW		8.4		9.1		10.6		
	Tbiv (bivalent temperature)	PERd %		108.8		108.4		100.8		
		TOL °C				-10				
		WTOL °C				35				
	Rated heat output supplementary capacity	COPd		3.01		2.99		2.72		
		Pdh kW		9.2		9.8		11.4		
		PERd %		120.4		119.6		108.8		
	Cold climate water outlet 35°C	General	Tbiv °C		-8		-7		-8	
			Psup (at Tdesign -10°C) kW		1.6		1.9		1.4	
			Annual energy consumption kWh		5,964		6,439		7,257	
			ηs (Seasonal space heating efficiency) %		162		165		160	
			Prated at -22°C kW		12		11		12	
Warm climate water outlet 35°C		Qhe Annual energy consumption (GCV) GJ		21		23		26		
		Annual energy consumption kWh		2,228		2,431		2,675		
		ηs (Seasonal space heating efficiency) %		237		239		237		
		Prated at 2°C kW		12		11		12		
		Qhe Annual energy consumption (GCV) GJ		8		9		10		
Space heating 	Warm climate water outlet 35°C	B Condition (2°CDB/-B/1°CWB)	Cdh (Degradation heating)			1.0				
			COPd		3.80		3.51		3.30	
			Pdh kW		9.2		11.0		11.9	
		C Condition (7°CDB/-B/6°CWB)	PERd %		152.0		140.4		132.0	
			Cdh (Degradation heating)				1.0			
			COPd		5.70		5.77		5.64	
	D Condition (12°CDB/11°CWB)	Pdh kW		6.7		7.4		8.1		
		PERd %		228.0		230.8		225.6		
		Tbiv COPd		3.80		3.51		3.30		
	Tbiv (bivalent temperature)	Pdh kW		9.2		11.0		11.9		
PERd %		152.0		140.4		132.0				
Tbiv °C		3			2					
Cdh (Degradation heating)				1.0						
D Condition (12°CDB/11°CWB)	COPd		7.87			7.73				
	Pdh kW				5.2					
	PERd %		314.8			309.2				

(1)Condition: Ta DB/WB 7°C/6°C - LWC 35°C (DT = 5°C) |

(2)Condition: Ta DB/WB 7°C/6°C - LWC 45°C (DT=5°C) |

(3)Measured with a pressure drop of 10 kPa in the heating system at an operating condition of leaving water 47-55°C in a room with an ambient of 20°C. DB/WB 7°C/6°C. |

Cooling: EW 12°C; LW 7°C; ambient conditions: 35°CDB |

Cooling: EW 23°C; LW 18°C; ambient conditions: 35°CDB |

According to EN14825 |

Condition 1: cooling Ta 35°C - LWE 18°C (DT = 5°C); heating Ta DB/WB 7°C/6°C - LWC 35°C (DT = 5°C) |

Condition 2: cooling Ta 35°C - LWE 7°C (DT = 5°C); heating Ta DB/WB 7°C/6°C - LWC 45°C (DT = 5°C) |

2 Specifications

1 - 1 ERLA11-16DW1

2

Technical specifications				EBSH11P30D + ERLA11DW1	EBSH11P50D + ERLA11DW1	EBSH16P30D + ERLA14DW1	EBSH16P50D + ERLA14DW1	EBSH16P30D + ERLA16DW1	EBSH16P50D + ERLA16DW1
Indoor unit				EBSH11P30DF	EBSH11P50DF	EBSH16P30DF	EBSH16P50DF	EBSH16P30DF	EBSH16P50DF
Outdoor unit				ERLA11DAW1		ERLA14DAW1		ERLA16DAW1	
Heating capacity	Nom.		kW	10.6 (1)		12.0 (1)		16.0 (1)	
Power input	Heating	Nom.	kW	2.19 (1)		2.46 (1)		3.53 (1)	
COP				4.83 (1)		4.87 (1)		4.53 (1)	
Pump	Type			Grundfos UPM3L K 20-75 CHBL AZA 3 RT		Grundfos UPML 20-105 CHBL 3H RT			
Water side Heat exchanger	Water flow rate	Heating	Nom.	l/min	30.3 (1)		34.4 (1)		45.9 (1)
General	Supplier/	Name and address		Daikin Europe N.V. - Zandvoordestraat 300, 8400 Oostende, Belgium					
	Manu- facturer details	Name or trademark		Daikin Europe N.V.					
Product descrip- tion	Air-to-water heat pump		Yes						
	Brine-to-water heat pump		No						
	Heat pump combination heater		Yes						
	Low-temperature heat pump		No						
	Supplementary heater integrated		No						
	Water-to-water heat pump		No						
LW(A) Sound power level (according to EN14825)	Indoor	dB(A)		44.7		49.0			
LW(A) Sound power level (according to EN14825)	Outdoor	dB(A)		62.0					
Sound condition Ecodesign and energy label				Sound power in heating mode, measured according to the EN12102 under conditions of the EN14825					
Space heating general	Air to water unit	Rated airflow (outdoor)	m ³ /h	3,350		4,220		5,100	
	Other	Capacity control		Inverter					
		Pck (Crankcase heater mode) kW		0.000					
		Poff (Off mode) kW		0.023					
		Psb (Standby mode) kW		0.023					
		Pto (Thermostat off) kW		0.023					
Domestic hot water heating 	General	Declared load profile		L	XL	L	XL	L	XL
		Function to fix water heating during off peak hours		No					
	Average climate	AEC (Annual electricity consumption)	kWh	887	1,313	887	1,313	887	1,313
		COPdhw		2.75	3.10	2.75	3.10	2.75	3.10
		Heat up time		1h 39min	2h 34min	1h 39min	2h 34min	1h 39min	2h 34min
		Mixed water at 40°C	l	196.0	242.0	196.0	242.0	196.0	242.0
		η _{wh} (water heating efficiency)	%	116	128	116	128	116	128
		Qelec (Daily electricity consumption)	kWh	4.236	6.149	4.236	6.149	4.236	6.149
		Reference hot water temperature	°C	46.9	44.1	46.9	44.1	46.9	44.1
		Stand-by power input	W	35.6	31.4	35.6	31.4	35.6	31.4
		Water heating energy efficiency class		A+					
	Cold climate	AEC (Annual electricity consumption)	kWh	1,051	1,526	1,051	1,526	1,051	1,526

2 Specifications

1 - 1 ERLA11-16DW1

Technical specifications			EBSH11P30D + ERLA11DW1	EBSH11P50D + ERLA11DW1	EBSH16P30D + ERLA14DW1	EBSH16P50D + ERLA14DW1	EBSH16P30D + ERLA16DW1	EBSH16P50D + ERLA16DW1	
Domestic hot water heating	Cold climate	COPdhw	2.33	2.67	2.33	2.67	2.33	2.67	
		Heat up time	1h 57min	2h 31min	1h 57min	2h 31min	1h 57min	2h 31min	
		Mixed water at 40°C	l	196.0	242.0	196.0	242.0	196.0	242.0
		η _{wh} (water heating efficiency)	%	98	110	98	110	98	110
		Qelec (Daily electricity consumption)	kWh	4.996	7.137	4.996	7.137	4.996	7.137
		Reference hot water temperature	°C	46.9	44.1	46.9	44.1	46.9	44.1
		Stand-by power input	W	38.5	34.4	38.5	34.4	38.5	34.4
	Warm climate	AEC (Annual electricity consumption)	kWh	750	1,078	750	1,078	750	1,078
		COPdhw		3.24	3.76	3.24	3.76	3.24	3.76
		Heat up time		1h 45min	2h 49min	1h 45min	2h 49min	1h 45min	2h 49min
		Mixed water at 40°C	l	196.0	242.0	196.0	242.0	196.0	242.0
		η _{wh} (water heating efficiency)	%	137	155	137	155	137	155
		Qelec (Daily electricity consumption)	kWh	3.604	5.073	3.604	5.073	3.604	5.073
		Reference hot water temperature	°C	46.9	44.1	46.9	44.1	46.9	44.1
Stand-by power input	W	34.5	30.5	34.5	30.5	34.5	30.5		
Space heating	Average climate water outlet 55°C	General	Annual energy consumption	kWh	6,397		7,047		
		η _s (Seasonal space heating efficiency)	%	126		130			
		Prated at -10°C	kW	10		11		12	
		Q _{he} Annual energy consumption (GCV)	Gj	23		25		27	
		SCOP		3.23		3.22		3.32	
		Seasonal space heating eff. class				A++			
		A Condition (-7°CDB/-8°CWB)	Cdh (Degradation heating)			1.0			
			COPd	1.89		1.80		1.95	
			Pdh	7.9		8.5		9.4	
			PERd	75.6		72.0		78.0	
		B Condition (2°CDB/1°CWB)	Cdh (Degradation heating)			1.0			
			COPd	3.25		3.28		3.27	
			Pdh	5.4		6.2		6.9	
			PERd	130.0		131.2		130.8	
		C Condition (7°CDB/6°CWB)	Cdh (Degradation heating)			1.0			
			COPd	4.81		4.88		4.93	
			Pdh	4.4		4.4		4.4	
			PERd	192.4		195.2		197.2	
		D Condition (12°CDB/11°CWB)	Cdh (Degradation heating)			1.0			
	COPd	6.41		6.58		6.60			
	Pdh	5.3		5.3		5.3			
	PERd	256.4		263.2		264.0			

2 Specifications

1 - 1 ERLA11-16DW1

2

Technical specifications				EBSH11P30D + ERLA11DW1	EBSH11P50D + ERLA11DW1	EBSH16P30D + ERLA14DW1	EBSH16P50D + ERLA14DW1	EBSH16P30D + ERLA16DW1	EBSH16P50D + ERLA16DW1	
Space heating	Average climate water outlet 55°C	Tol (temperature operating limit)	COPd	1.68		1.76		1.50		
			Pdh kW	6.8		7.0		6.0		
			PERd %	67.2		70.4		60.0		
			TOL °C			-10				
			WTOL °C			55				
		Rated heat output supplementary capacity	Psup (at Tdesign -10°C)	kW	3.2		4.0		6.1	
		Tbiv (bivalent temperature)	COPd	1.96		1.87		2.13		
			Pdh kW	8.2		8.9		10.1		
			PERd %	78.4		74.8		85.2		
			Tbiv °C			-5				
Cold climate water outlet 55°C	General	Annual energy consumption	kWh	8,082		9,024		9,561		
		ηs (Seasonal space heating efficiency)	%	119		117		121		
		Prated at -22°C	kW	10		11		12		
		Qhe Annual energy consumption (GCV)	Gj	29		32		34		
	A Condition (7°CDB/-8°CWB)	CdH (Degradation heating)				1.0				
			COPd		2.65		2.63		2.64	
			Pdh kW		6.3		7.0		7.3	
			PERd %		106.0		105.2		105.6	
	B Condition (2°CDB/-1°CWB)	CdH (Degradation heating)				1.0				
			COPd		4.12		3.96		3.98	
		Pdh kW		3.9		4.4		4.5		
		PERd %		164.8		158.4		159.2		
C Condition (7°CDB/-6°CWB)	CdH (Degradation heating)				1.0					
		COPd		5.14		5.21		5.39		
		Pdh kW			4.5		4.6			
		PERd %		205.6		208.4		215.6		
D Condition (12°CDB/11°CWB)	CdH (Degradation heating)				1.0					
		COPd		6.88		6.62		6.26		
		Pdh kW			5.4		5.0			
		PERd %		275.2		264.8		250.4		
Tol (temperature operating limit)		COPd		1.84		1.81		2.06		
		Pdh kW		7.5		8.0		9.7		
		PERd %		73.6		72.4		82.4		
		TOL °C				-15				
		WTOL °C				49				
G Condition (-15°CDB/-)	CdH (Degradation heating)				1.0					
		COPd		1.84		1.81		2.06		
		Pdh kW		7.5		8.0		9.7		
		PERd %		73.6		72.4		82.4		

2 Specifications

1 - 1 ERLA11-16DW1

Technical specifications				EBSH11P30D + ERLA11DW1	EBSH11P50D + ERLA11DW1	EBSH16P30D + ERLA14DW1	EBSH16P50D + ERLA14DW1	EBSH16P30D + ERLA16DW1	EBSH16P50D + ERLA16DW1	
Space heating 	Cold climate water outlet 55°C	Tbiv	COPd	1.88		2.02		2.06		
		Pdh	kW	7.1		7.8		9.7		
		PERd	%	75.2		80.8		82.4		
		Tbiv	°C	-12		-11		-15		
		Rated heat output supplementary capacity	Psup (at Tdesign -22°C)	kW	0.6		1.0		0.0	
	Warm climate water outlet 55°C	General	Annual energy consumption	kWh	3,258		3,818		3,792	
			ηs (Seasonal space heating efficiency)	%	161		166		168	
			Prated at 2°C	kW	10				12.1	
			Qhe Annual energy consumption (GCV)	Gj	12				14	
			Cdh (Degradation heating)				1.0			
		B Condition (2°CDB/1°CWB)	COPd		2.24		2.20		2.17	
			Pdh	kW	9.0		10.1		9.8	
			PERd	%	89.6		88.0		86.8	
		C Condition (7°CDB/6°CWB)	Cdh (Degradation heating)				1.0			
			COPd		3.74			3.83		
			Pdh	kW	6.2			7.6		
		D Condition (12°CDB/11°CWB)	PERd	%	149.6			153.2		
			Cdh (Degradation heating)				1.0			
			COPd		5.68			5.69		
		Average climate water outlet 35°C	General	Pdh	kW			5.0		
PERd	%			227.2			227.6			
Tbiv	COPd			2.41		2.65		2.40		
Pdh	kW			8.5		11.1		11.0		
PERd	%			96.4		106.0		96.0		
General	Tbiv		°C		4			3		
	Annual energy consumption		kWh	4,462		4,935		5,377		
	ηs (Seasonal space heating efficiency)		%	182			181			
	Prated at -10°C		kW	10		11		12		
	Qhe Annual energy consumption (GCV)		Gj	16		18		19		
A Condition (7°CDB/-8°CWB)	SCOP		4.63		4.60		4.61			
	Seasonal space heating eff. class				A+++					
	COPd		3.03		2.99		2.87			
	Pdh	kW	9.2		9.8		11.2			
	PERd	%	121.2		119.6		114.8			
	B Condition (2°CDB/1°CWB)	Cdh (Degradation heating)				1.0				
		COPd		4.37		4.35		4.33		
Pdh		kW	5.5		6.1		6.7			

2 Specifications

1 - 1 ERLA11-16DW1

2

Technical specifications				EBSH11P30D + ERLA11DW1	EBSH11P50D + ERLA11DW1	EBSH16P30D + ERLA14DW1	EBSH16P50D + ERLA14DW1	EBSH16P30D + ERLA16DW1	EBSH16P50D + ERLA16DW1		
Space heating	Average climate water outlet 35°C	B Condition (2°CDB/1°CWB)	PERd	%	174.8		174.0		173.2		
		C Condition (7°CDB/6°CWB)	Cdh (Degradation heating)				1.0				
			COPd		6.74		6.70		6.83		
			Pdh	kW		4.6			4.7		
			PERd	%	269.6		268.0		273.2		
			D Condition (12°CDB/11°CWB)	Cdh (Degradation heating)				1.0			
			COPd		8.54		8.65		8.82		
			Pdh	kW		5.4			5.5		
			PERd	%	341.6		346.0		352.8		
			Tol (temperature operating limit)	COPd		2.73		2.71		2.52	
				Pdh	kW	8.4		9.1		10.6	
				PERd	%	109.2		108.4		100.8	
				TOL	°C			-10			
				WTOL	°C			35			
				Tbiv (bivalent temperature)	COPd		3.01		2.99		2.72
					Pdh	kW	9.2		9.8		11.4
					PERd	%	120.4		119.6		108.8
					Tbiv	°C	-8		-7		-8
				Rated heat output supplementary capacity	Psup (at Tdesign -10°C)	kW	1.6		1.9		1.4
		Cold climate water outlet 35°C	General	Annual energy consumption	kWh	5,951		6,439		7,257	
ηs (Seasonal space heating efficiency)	%			163		165		160			
Prated at -22°C	kW			10		11		12			
Qhe Annual energy consumption (GCV)	Gj			21		23		26			
	A Condition (-7°CDB/-8°CWB)		COPd		3.81		3.58		3.48		
			Pdh	kW	6.2		7.0		7.5		
			PERd	%	152.4		143.2		139.2		
	B Condition (2°CDB/1°CWB)		Cdh (Degradation heating)				1.0				
			COPd		5.02		5.41		4.83		
			Pdh	kW	3.6		4.3		4.5		
			PERd	%	200.8		216.4		193.2		
	C Condition (7°CDB/6°CWB)		Cdh (Degradation heating)				1.0				
			COPd		7.31		7.03		7.36		
			Pdh	kW	5.1		4.8		5.0		
			PERd	%	292.4		281.2		294.4		
			D Condition (12°CDB/11°CWB)	Cdh (Degradation heating)					1.0		
		COPd		8.82		8.80		8.78			
		Pdh	kW	5.7		5.8		5.7			

2 Specifications

1 - 1 ERLA11-16DW1

Technical specifications					EBSH11P30D + ERLA11DW1	EBSH11P50D + ERLA11DW1	EBSH16P30D + ERLA14DW1	EBSH16P50D + ERLA14DW1	EBSH16P30D + ERLA16DW1	EBSH16P50D + ERLA16DW1
Space heating 	Cold climate water outlet 35°C	D Condition (12°CDB/11°CWB)	PERd	%	352.8		352.0		351.2	
		Tol (temperature operating limit)	COPd		2.24		2.23		2.14	
			Pdh	kW	6.8		7.3		9.2	
			PERd	%	89.6		89.2		85.6	
			TOL	°C			-20			
			WTOL	°C			34			
		G Condition (-15°CDB/-)	COPd		2.48		2.50		2.40	
			Pdh	kW	7.0		7.7		9.7	
			PERd	%	99.2		100.0		96.0	
		Tbiv (bivalent temperature)	COPd		2.62		2.81		2.40	
			Pdh	kW	7.3		8.7		9.7	
			PERd	%	104.8		112.4		96.0	
			Tbiv	°C			-12		-15	
		Rated heat output supplementary capacity	Psup (at Tdesign -22°C)	kW	2.7		3.2		2.2	
		Warm climate water outlet 35°C	General	Annual energy consumption	kWh	2,228		2,431		2,675
ηs (Seasonal space heating efficiency)	%			237		239		237		
Prated at 2°C	kW			10		11		12		
Qhe Annual energy consumption (GCV)	Gj			8		9		10		
B Condition (2°CDB/1°CWB)	Cdh (Degradation heating)						1.0			
	COPd			3.64		3.51		3.30		
	Pdh		kW	9.8		11.0		11.9		
	PERd		%	145.6		140.4		132.0		
C Condition (7°CDB/6°CWB)	Cdh (Degradation heating)					1.0				
	COPd			5.70		5.77		5.64		
	Pdh		kW	6.7		7.4		8.1		
	PERd		%	228.0		230.8		225.6		
Tbiv (bivalent temperature)	COPd			3.81		3.51		3.30		
	Pdh		kW	9.2		11.0		11.9		
	PERd		%	152.4		140.4		132.0		
	Tbiv	°C	3				2			
D Condition (12°CDB/11°CWB)	Cdh (Degradation heating)				1.0					
	COPd		7.87				7.73			
	Pdh	kW			5.2					
	PERd	%	314.8				309.2			

(1)Condition 1: cooling Ta 35°C - LWE 18°C (DT = 5°C); heating Ta DB/WB 7°C/6°C - LWC 35°C (DT = 5°C) | Condition 2: cooling Ta 35°C - LWE 7°C (DT = 5°C); heating Ta DB/WB 7°C/6°C - LWC 45°C (DT = 5°C)

Technical specifications					EBSX11P30D + ERLA11DW1	EBSX11P50D + ERLA11DW1	EBSX16P30D + ERLA14DW1	EBSX16P50D + ERLA14DW1	EBSX16P30D + ERLA16DW1	EBSX16P50D + ERLA16DW1
Indoor unit					EBSX11P30DF	EBSX11P50DF	EBSX16P30DF	EBSX16P50DF	EBSX16P30DF	EBSX16P50DF
Outdoor unit					ERLA11DAW1		ERLA14DAW1		ERLA16DAW1	
Heating capacity	Nom.		kW	10.6 (1)		12.0 (1)		16.0 (1)		
Cooling capacity	Nom.		kW	11.2 (2)		12.9 (2)		13.6 (2)		
Power input	Heating	Nom.	kW	2.19 (1)		2.46 (1)		3.53 (1)		
	Cooling	Nom.	kW	3.47 (2)		4.34 (2)		4.68 (2)		
COP					4.83 (1)		4.87 (1)		4.53 (1)	
EER					3.22 (2)		2.98 (2)		2.91 (2)	
Pump					Grundfos UPM3L K 20-75 CHBL AZA 3 RT		Grundfos UPML 20-105 CHBL 3H RT			
Water side Heat exchanger	Water flow rate	Cooling	Nom.	l/min	32.1 (2)		37.1 (2)		39.1 (2)	
		Heating	Nom.	l/min	30.3 (1)		34.4 (1)		45.9 (1)	

2 Specifications

1 - 1 ERLA11-16DW1

2

Technical specifications			EBSX11P30D + ERLA11DW1	EBSX11P50D + ERLA11DW1	EBSX16P30D + ERLA14DW1	EBSX16P50D + ERLA14DW1	EBSX16P30D + ERLA16DW1	EBSX16P50D + ERLA16DW1	
General	Supplier/Manu- facturer details	Name and address	Daikin Europe N.V. - Zandvoordestraat 300, 8400 Oostende, Belgium						
		Name or trademark	Daikin Europe N.V.						
	Product descrip- tion	Air-to-water heat pump		Yes					
		Brine-to-water heat pump		No					
		Heat pump combination heater		Yes					
		Low-temperature heat pump		No					
		Supplementary heater integrated		No					
		Water-to-water heat pump		No					
	LW(A) Sound power level (according to EN14825)	Indoor	dB(A)	44.7		49.0			
	LW(A) Sound power level (according to EN14825)	Outdoor	dB(A)	62.0					
Sound condition Ecodesign and energy label			Sound power in heating mode, measured according to the EN12102 under conditions of the EN14825						
Space heating general	Air to water unit	Rated airflow (outdoor)	m ³ /h	3,350		4,220		5,100	
	Other	Capacity control		Inverter					
		Pck (Crankcase heater mode)	kW	0.000					
		Poff (Off mode)	kW	0.023					
		Psb (Standby mode)	kW	0.023					
	Pto (Thermostat off)	kW	0.023						
Domestic hot water heating	General	Declared load profile		L	XL	L	XL	L	XL
		Function to fix water heating during off peak hours		No					
	Average climate	AEC (Annual electricity consumption)	kWh	887	1,313	887	1,313	887	1,313
		COPdhw		2.75	3.10	2.75	3.10	2.75	3.10
		Heat up time		1h 39min	2h 34min	1h 39min	2h 34min	1h 39min	2h 34min
		Mixed water at 40°C	l	196.0	242.0	196.0	242.0	196.0	242.0
		η _{wh} (water heating efficiency)	%	116	128	116	128	116	128
		Qelec (Daily electricity consumption)	kWh	4.236	6.149	4.236	6.149	4.236	6.149
			Water heating energy efficiency class		A+				
	Domestic hot water heating	Average climate	Reference hot water temperature	°C	46.9	44.1	46.9	44.1	46.9
Stand-by power input			W	35.6	31.4	35.6	31.4	35.6	31.4
Cold climate		AEC (Annual electricity consumption)	kWh	1,051	1,526	1,051	1,526	1,051	1,526
		COPdhw		2.33	2.67	2.33	2.67	2.33	2.67
		Heat up time		1h 57min	2h 31min	1h 57min	2h 31min	1h 57min	2h 31min
		Mixed water at 40°C	l	196.0	242.0	196.0	242.0	196.0	242.0
		η _{wh} (water heating efficiency)	%	98	110	98	110	98	110
		Qelec (Daily electricity consumption)	kWh	4.996	7.137	4.996	7.137	4.996	7.137
		Reference hot water temperature	°C	46.9	44.1	46.9	44.1	46.9	44.1
		Stand-by power input	W	38.5	34.4	38.5	34.4	38.5	34.4
Warm climate	AEC (Annual electricity consumption)	kWh	750	1,078	750	1,078	750	1,078	
	COPdhw		3.24	3.76	3.24	3.76	3.24	3.76	
	Heat up time		1h 45min	2h 49min	1h 45min	2h 49min	1h 45min	2h 49min	
	Mixed water at 40°C	l	196.0	242.0	196.0	242.0	196.0	242.0	
	η _{wh} (water heating efficiency)	%	137	155	137	155	137	155	
	Qelec (Daily electricity consumption)	kWh	3.604	5.073	3.604	5.073	3.604	5.073	
	Reference hot water temperature	°C	46.9	44.1	46.9	44.1	46.9	44.1	
	Stand-by power input	W	34.5	30.5	34.5	30.5	34.5	30.5	

2 Specifications

1 - 1 ERLA11-16DW1

Technical specifications				EBSX11P30D + ERLA11DW1	EBSX11P50D + ERLA11DW1	EBSX16P30D + ERLA14DW1	EBSX16P50D + ERLA14DW1	EBSX16P30D + ERLA16DW1	EBSX16P50D + ERLA16DW1		
Space heating 	Average climate water outlet 55°C	General	Annual energy consumption	kWh	6,312		6,962		7,392		
			ηs (Seasonal space heating efficiency)	%	128				131		
			Prated at -10°C	kW	10		11		12		
			Qhe Annual energy consumption (GCV)	Gj	23		25		27		
			SCOP		3.27		3.26		3.35		
			Seasonal space heating eff. class				A++				
			A Condition (-7°CDB/-8°CWB)	Cdh (Degradation heating)				1.0			
				COPd		1.89		1.80		1.95	
				Pdh	kW	7.9		8.5		9.4	
				PERd	%	75.6		72.0		78.0	
			B Condition (2°CDB/-1°CWB)	Cdh (Degradation heating)				1.0			
				COPd		3.25		3.28		3.27	
				Pdh	kW	5.4		6.2		6.9	
			C Condition (7°CDB/6°CWB)	Cdh (Degradation heating)				1.0			
				COPd		4.81		4.88		4.93	
				Pdh	kW	192.4		195.2		197.2	
			Space heating 	Average climate water outlet 55°C	D Condition (12°CDB/11°CWB)	Cdh (Degradation heating)				1.0	
COPd		6.41				6.58		6.60			
Pdh	kW	256.4				263.2		264.0			
PERd	%	1.68				1.76		1.50			
Tol (temperature operating limit)	Pdh	kW				6.8		7.0		6.0	
	PERd	%				67.2		70.4		60.0	
	TOL	°C						-10			
Rated heat output supplementary capacity	WTOL	°C						55			
	Psup (at Tdesign -10°C)	kW				3.2		4.0		6.1	
	Tbiv	COPd				1.96		1.87		2.13	
(bivalent temperature)	Pdh	kW				8.2		8.9		10.1	
	PERd	%				78.4		74.8		85.2	
	Tbiv	°C						-5			
Cold climate water outlet 55°C	General	Annual energy consumption				kWh	8,031		8,974		9,510
		ηs (Seasonal space heating efficiency)				%	120		118		121
		Prated at -22°C				kW	10		11		12
		Qhe Annual energy consumption (GCV)				Gj	29		32		34
		A Condition (-7°CDB/-8°CWB)	Cdh (Degradation heating)				1.0				
			COPd		2.65		2.63		2.64		
			Pdh	kW	6.3		7.0		7.3		
			PERd	%	106.0		105.2		105.6		
		B Condition (2°CDB/1°CWB)	Cdh (Degradation heating)				1.0				
			COPd		4.12		3.96		3.98		
			Pdh	kW	3.9		4.4		4.5		
		C Condition (7°CDB/6°CWB)	Cdh (Degradation heating)				1.0				
			COPd		5.14		5.21		5.39		
			Pdh	kW	205.6		208.4		215.6		
		D Condition (12°CDB/11°CWB)	COPd		6.88		6.62		6.26		
			Pdh	kW			5.4		5.0		
			PERd	%	275.2		264.8		250.4		
Tol (temperature operating limit)	COPd		1.84		1.81		2.06				
	Pdh	kW	7.5		8.0		9.7				
	PERd	%	73.6		72.4		82.4				
TOL	°C			-15							

2 Specifications

1 - 1 ERLA11-16DW1

2

Technical specifications				EBSX11P30D + ERLA11DW1	EBSX11P50D + ERLA11DW1	EBSX16P30D + ERLA14DW1	EBSX16P50D + ERLA14DW1	EBSX16P30D + ERLA16DW1	EBSX16P50D + ERLA16DW1
Space heating Cold climate water outlet 55°C	Tol (tem- perature operat- ing limit)	WTOL	°C	49					
		G Con- dition (-15°CDB/-)	COPd		1.84		1.81		2.06
			Pdh	kW	7.5		8.0		9.7
			PERd	%	73.6		72.4		82.4
		Tbiv (bivalent tempera- ture)	COPd		1.88		2.02		2.06
			Pdh	kW	7.1		7.8		9.7
			PERd	%	75.2		80.8		82.4
		Rated heat output supple- mentary capacity	Tbiv	°C	-12		-11		-15
			Psup (at Tdesign -22°C)	kW	0.6		1.0		0.0
Warm climate water outlet 55°C	General	Annual energy consumption	kWh	3,157		3,717		3,690	
		ηs (Seasonal space heating efficiency)	%	166		171		172	
		Prated at 2°C	kW	10			12.1		
		Qhe Annual ener- gy consumption (GCV)	Gj	11			13		
	B Con- dition (2°CDB- B/1°CWB)	Cdh (Degradation heating)				1.0			
		COPd		2.24		2.20		2.17	
		Pdh	kW	9.0		10.1		9.8	
	C Con- dition (7°CDB- B/6°CWB)	PERd	%	89.6		88.0		86.8	
		Cdh (Degradation heating)				1.0			
		COPd		3.74			3.83		
	D Condition (12°CDB/11°CWB)	Pdh	kW	6.2			7.6		
		PERd	%	149.6			153.2		
		Cdh (Degradation heating)				1.0			
	Tbiv (bivalent tempera- ture)	COPd		5.68			5.69		
		Pdh	kW			5.0			
PERd		%	227.2			227.6			
COPd			2.41		2.65		2.40		
Pdh		kW	8.5		11.1		11.0		
PERd		%	96.4		106.0		96.0		
Average climate water outlet 35°C	General	Tbiv	°C		4			3	
		Annual energy consumption	kWh	4,378		4,851		5,293	
		ηs (Seasonal space heating efficiency)	%	186			184		
		Prated at -10°C	kW	10		11		12	
	Qhe Annual ener- gy consumption (GCV)	Gj		16		17		19	
		SCOP		4.72			4.68		
		Seasonal space heating eff. class				A+++			
	A Condition (7°CDB/8°CWB)	COPd		3.03		2.99		2.87	
		Pdh	kW	9.2		9.8		11.2	

2 Specifications

1 - 1 ERLA11-16DW1

Technical specifications				EBSX11P30D + ERLA11DW1	EBSX11P50D + ERLA11DW1	EBSX16P30D + ERLA14DW1	EBSX16P50D + ERLA14DW1	EBSX16P30D + ERLA16DW1	EBSX16P50D + ERLA16DW1	
Space heating 	Average climate water outlet 35°C	A Condition (-7°CDB/-8°CWB)	PERd	%	121.2		119.6		114.8	
		B Condition (2°CDB/-1°CWB)	Cdh (Degradation heating)				1.0			
			COPd		4.37		4.35		4.33	
			Pdh	kW	5.5		6.1		6.7	
			PERd	%	174.8		174.0		173.2	
			C Condition (7°CDB/-6°CWB)	Cdh (Degradation heating)				1.0		
			COPd		6.74		6.70		6.83	
			Pdh	kW		4.6		4.7		
			PERd	%	269.6		268.0		273.2	
			D Condition (12°CDB/11°CWB)	Cdh (Degradation heating)				1.0		
			COPd		8.54		8.65		8.82	
			Pdh	kW		5.4		5.5		
			PERd	%	341.6		346.0		352.8	
			Tol (temperature operating limit)	COPd		2.73		2.71		2.52
			Pdh	kW		8.4		9.1		10.6
			PERd	%		109.2		108.4		100.8
			TOL	°C				-10		
			WTOL	°C				35		
			Tbiv (bivalent temperature)	COPd		3.01		2.99		2.72
			Pdh	kW		9.2		9.8		11.4
	PERd	%		120.4		119.6		108.8		
	Tbiv	°C		-8		-7		-8		
	Rated heat output supplementary capacity	Psup (at Tdesign -10°C)	kW	1.6		1.9		1.4		
Cold climate water outlet 35°C	General	Annual energy consumption	kWh	5,901		6,388		7,206		
		ηs (Seasonal space heating efficiency)	%	164		167		161		
		Prated at -22°C	kW	10		11		12		
		Qhe Annual energy consumption (GCV)	Gj	21		23		26		
		A Condition (-7°CDB/-8°CWB)	COPd		3.81		3.58		3.48	
		Pdh	kW	6.2		7.0		7.5		
		PERd	%	152.4		143.2		139.2		
		B Condition (2°CDB/-1°CWB)	Cdh (Degradation heating)				1.0			
		COPd		5.02		5.41		4.83		
		Pdh	kW	3.6		4.3		4.5		
		PERd	%	200.8		216.4		193.2		
		C Condition (7°CDB/6°CWB)	Cdh (Degradation heating)				1.0			
		COPd		7.31		7.03		7.36		
		Pdh	kW	5.1		4.8		5.0		

2 Specifications

1 - 1 ERLA11-16DW1

2



Technical specifications					EBSX11P30D + ERLA11DW1	EBSX11P50D + ERLA11DW1	EBSX16P30D + ERLA14DW1	EBSX16P50D + ERLA14DW1	EBSX16P30D + ERLA16DW1	EBSX16P50D + ERLA16DW1	
Space heating 	Cold climate water outlet 35°C	C Condition (7°CDB- B/6°CWB)	PERd	%	292.4		281.2		294.4		
			D Condition (12°CDB/11°CWB)			Cdh (Degradation heating)			1.0		
					COPd		8.82		8.80		8.78
					Pdh	kW	5.7		5.8		5.7
					PERd	%	352.8		352.0		351.2
		Tol (temperature operating limit)			COPd		2.24		2.23		2.14
					Pdh	kW	6.8		7.3		9.2
					PERd	%	89.6		89.2		85.6
					TOL	°C	-20				
					WTOL	°C	34				
	G Condition (-15°CDB/-)			COPd		2.48		2.50		2.40	
				Pdh	kW	7.0		7.7		9.7	
				PERd	%	99.2		100.0		96.0	
	Tbiv (bivalent temperature)			COPd		2.62		2.81		2.40	
				Pdh	kW	7.3		8.7		9.7	
				PERd	%	104.8		112.4		96.0	
				Tbiv	°C	-12				-15	
	Rated heat output supplementary capacity			Psup (at Tdesign -22°C)	kW	2.7		3.2		2.2	
	Warm climate water outlet 35°C	General	Annual energy consumption		kWh	2,126		2,330		2,573	
			ηs (Seasonal space heating efficiency)		%	248		249		246	
Prated at 2°C			kW	10		11		12			
Qhe Annual energy consumption (GCV)			Gj	8		9					
B Condition (2°CDB- B/1°CWB)			Cdh (Degradation heating)			1.0					
			COPd		3.64		3.51		3.30		
			Pdh	kW	9.8		11.0		11.9		
			PERd	%	145.6		140.4		132.0		
C Condition (7°CDB- B/6°CWB)			Cdh (Degradation heating)			1.0					
			COPd		5.70		5.77		5.64		
			Pdh	kW	6.7		7.4		8.1		
			PERd	%	228.0		230.8		225.6		
Tbiv (bivalent temperature)			COPd		3.81		3.51		3.30		
			Pdh	kW	9.2		11.0		11.9		
			PERd	%	152.4		140.4		132.0		
			Tbiv	°C	3		2				
D Condition (12°CDB/11°CWB)			Cdh (Degradation heating)			1.0					
			COPd		7.87		7.73				
			Pdh	kW	5.2						
Space heating 	Warm climate water outlet 35°C	D Condition (12°CDB/11°CWB)	PERd	%	314.8		309.2				

(1)Condition 1: cooling Ta 35°C - LWE 18°C (DT = 5°C); heating Ta DB/WB 7°C/6°C - LWC 35°C (DT = 5°C) |
 (2)Condition 2: cooling Ta 35°C - LWE 7°C (DT = 5°C); heating Ta DB/WB 7°C/6°C - LWC 45°C (DT = 5°C)

Technical specifications					EBSHB11P30D + ERLA11DW1	EBSHB11P50D + ERLA11DW1	EBSHB16P30D + ERLA14DW1	EBSHB16P50D + ERLA14DW1	EBSHB16P30D + ERLA16DW1	EBSHB16P50D + ERLA16DW1
Indoor unit					EBSHB11P30DF	EBSHB11P50DF	EBSHB16P30DF	EBSHB16P50DF	EBSHB16P30DF	EBSHB16P50DF
Outdoor unit					ERLA11DAW1		ERLA14DAW1		ERLA16DAW1	
Heating capacity	Nom.			kW	10.6 (1)		12.0 (1)		16.0 (1)	
Power input	Heating	Nom.		kW	2.19 (1)		2.46 (1)		3.53 (1)	
COP					4.83 (1)		4.87 (1)		4.53 (1)	
Pump	Type				Grundfos UPM3L K 20-75 CHBL AZA 3 RT		Grundfos UPML 20-105 CHBL 3H RT			
Water side Heat exchanger	Water flow rate	Heating	Nom.	l/min	30.3 (1)		34.4 (1)		45.9 (1)	

2 Specifications

1 - 1 ERLA11-16DW1

Technical specifications			EBSHB11P30D + ERLA11DW1	EBSHB11P50D + ERLA11DW1	EBSHB16P30D + ERLA14DW1	EBSHB16P50D + ERLA14DW1	EBSHB16P30D + ERLA16DW1	EBSHB16P50D + ERLA16DW1		
General	Supplier/Manu- facturer details	Name and address	Daikin Europe N.V. - Zandvoordestraat 300, 8400 Oostende, Belgium							
		Name or trademark	Daikin Europe N.V.							
	Product descrip- tion	Air-to-water heat pump		Yes						
		Brine-to-water heat pump		No						
		Heat pump combination heater		Yes						
		Low-temperature heat pump		No						
		Supplementary heater integrated		No						
Water-to-water heat pump		No								
LW(A) Sound power level (according to EN14825)	Indoor	dB(A)	44.7			49.0				
LW(A) Sound power level (according to EN14825)	Outdoor	dB(A)	62.0							
Sound condition Ecodesign and energy label			Sound power in heating mode, measured according to the EN12102 under conditions of the EN14825							
Space heating general	Air to water unit	Rated airflow (outdoor)	m ³ /h	3,350		4,220		5,100		
	Other	Capacity control		Inverter						
		Pck (Crankcase heater mode)	kW	0.000						
		Poff (Off mode)	kW	0.023						
		Psb (Standby mode)	kW	0.023						
Pto (Thermostat off)	kW	0.023								
Domestic hot water heating 	General	Declared load profile		L	XL	L	XL	L	XL	
		Function to fix water heating during off peak hours		No						
	Average climate	AEC (Annual electricity consumption)	kWh	887	1,313	887	1,313	887	1,313	
		COPdhw		2.75	3.10	2.75	3.10	2.75	3.10	
		Heat up time		1h 39min	2h 34min	1h 39min	2h 34min	1h 39min	2h 34min	
		Mixed water at 40°C	l	196.0	242.0	196.0	242.0	196.0	242.0	
		η _{wh} (water heating efficiency)	%	116	128	116	128	116	128	
		Qelec (Daily electricity consumption)	kWh	4.236	6.149	4.236	6.149	4.236	6.149	
		Reference hot water temperature	°C	46.9	44.1	46.9	44.1	46.9	44.1	
		Stand-by power input	W	35.6	31.4	35.6	31.4	35.6	31.4	
		Water heating energy efficiency class		A+						
		Cold climate	AEC (Annual electricity consumption)	kWh	1,051	1,526	1,051	1,526	1,051	1,526
	COPdhw			2.33	2.67	2.33	2.67	2.33	2.67	
	Domestic hot water heating 	Cold climate	Heat up time		1h 57min	2h 31min	1h 57min	2h 31min	1h 57min	2h 31min
			Mixed water at 40°C	l	196.0	242.0	196.0	242.0	196.0	242.0
η _{wh} (water heating efficiency)		%	98	110	98	110	98	110		
Qelec (Daily electricity consumption)		kWh	4.996	7.137	4.996	7.137	4.996	7.137		
Reference hot water temperature		°C	46.9	44.1	46.9	44.1	46.9	44.1		
Stand-by power input		W	38.5	34.4	38.5	34.4	38.5	34.4		
Warm climate		AEC (Annual electricity consumption)	kWh	750	1,078	750	1,078	750	1,078	
	COPdhw		3.24	3.76	3.24	3.76	3.24	3.76		
	Heat up time		1h 45min	2h 49min	1h 45min	2h 49min	1h 45min	2h 49min		
	Mixed water at 40°C	l	196.0	242.0	196.0	242.0	196.0	242.0		
	η _{wh} (water heating efficiency)	%	137	155	137	155	137	155		
	Qelec (Daily electricity consumption)	kWh	3.604	5.073	3.604	5.073	3.604	5.073		
	Reference hot water temperature	°C	46.9	44.1	46.9	44.1	46.9	44.1		
Stand-by power input	W	34.5	30.5	34.5	30.5	34.5	30.5			

2 Specifications

1 - 1 ERLA11-16DW1

2

Technical specifications				EBSHB11P30D + ERLA11DW1	EBSHB11P50D + ERLA11DW1	EBSHB16P30D + ERLA14DW1	EBSHB16P50D + ERLA14DW1	EBSHB16P30D + ERLA16DW1	EBSHB16P50D + ERLA16DW1
Space heating	Average climate water outlet 55°C	General	Annual energy consumption	kWh	6,397		7,047		7,477
			ηs (Seasonal space heating efficiency)	%	126				130
			Prated at -10°C	kW	10		11		12
			Qhe Annual energy consumption (GCV)	Gj	23		25		27
			SCOP		3.23		3.22		3.32
			Seasonal space heating eff. class		A++				
			A Condition (-7°CDB/-8°CWB)	Cdh (Degradation heating)		1.0			
				COPd	1.89		1.80		1.95
				Pdh	7.9		8.5		9.4
				PERd	75.6		72.0		78.0
			B Condition (2°CDB/-1°CWB)	Cdh (Degradation heating)		1.0			
				COPd	3.25		3.28		3.27
				Pdh	5.4		6.2		6.9
				PERd	130.0		131.2		130.8
			C Condition (7°CDB/6°CWB)	Cdh (Degradation heating)		1.0			
			COPd	4.81		4.88		4.93	
			Pdh			4.4			
			PERd	192.4		195.2		197.2	
		D Condition (12°CDB/11°CWB)	Cdh (Degradation heating)		1.0				
			COPd	6.41		6.58		6.60	
			Pdh			5.3			
			PERd	256.4		263.2		264.0	

2 Specifications

1 - 1 ERLA11-16DW1

Technical specifications				EBSHB11P30D + ERLA11DW1	EBSHB11P50D + ERLA11DW1	EBSHB16P30D + ERLA14DW1	EBSHB16P50D + ERLA14DW1	EBSHB16P30D + ERLA16DW1	EBSHB16P50D + ERLA16DW1	
Space heating 	Average climate water outlet 55°C	Tol (temperature operating limit)	COPd	1.68		1.76		1.50		
			Pdh kW	6.8		7.0		6.0		
			PERd %	67.2		70.4		60.0		
			TOL °C			-10				
			WTOL °C			55				
		Rated heat output supplementary capacity	Psup (at Tdesign -10°C)	kW	3.2		4.0		6.1	
	Cold climate water outlet 55°C	General	Tbiv (bivalent temperature)	COPd	1.96		1.87		2.13	
				Pdh kW	8.2		8.9		10.1	
				PERd %	78.4		74.8		85.2	
				Tbiv °C			-5			
			Annual energy consumption	kWh	8,082		9,024		9,561	
	ηs (Seasonal space heating efficiency)	%	119		117		121			
	Prated at -22°C	kW	10		11		12			
	Qhe Annual energy consumption (GCV)	Gj	29		32		34			
	A Condition (7°CDB/-8°CWB)	Cdh (Degradation heating)				1.0				
		COPd		2.65		2.63		2.64		
		Pdh kW		6.3		7.0		7.3		
		PERd %		106.0		105.2		105.6		
	B Condition (2°CDB/-1°CWB)	Cdh (Degradation heating)				1.0				
		COPd		4.12		3.96		3.98		
		Pdh kW		3.9		4.4		4.5		
		PERd %		164.8		158.4		159.2		
	C Condition (7°CDB/-6°CWB)	Cdh (Degradation heating)				1.0				
		COPd		5.14		5.21		5.39		
		Pdh kW			4.5		4.6			
		PERd %		205.6		208.4		215.6		
	D Condition (12°CDB/11°CWB)	COPd				6.88		6.62		
		Pdh kW			5.4		5.0			
		PERd %		275.2		264.8		250.4		
	Tol (temperature operating limit)	COPd		1.84		1.81		2.06		
		Pdh kW		7.5		8.0		9.7		
		PERd %		73.6		72.4		82.4		
		TOL °C				-15				
		WTOL °C				49				
	G Condition (-15°CDB/-)	COPd				1.84		1.81		
		Pdh kW		7.5		8.0		9.7		
		PERd %		73.6		72.4		82.4		

2 Specifications

1 - 1 ERLA11-16DW1

2

Technical specifications				EBSHB11P30D + ERLA11DW1	EBSHB11P50D + ERLA11DW1	EBSHB16P30D + ERLA14DW1	EBSHB16P50D + ERLA14DW1	EBSHB16P30D + ERLA16DW1	EBSHB16P50D + ERLA16DW1	
Space heating	Cold climate water outlet 55°C	Tbiv	COPd	1.88			2.02		2.06	
		Pdh	kW	7.1			7.8		9.7	
		PERd	%	75.2			80.8		82.4	
		Tbiv	°C	-12			-11		-15	
		Rated heat output supplementary capacity	Psup (at Tdesign -22°C)	kW	0.6			1.0		0.0
	Warm climate water outlet 55°C	General	Annual energy consumption	kWh	3,258			3,818		3,792
			ηs (Seasonal space heating efficiency)	%	161			166		168
			Prated at 2°C	kW	10				12.1	
			Qhe Annual energy consumption (GCV)	Gj	12				14	
			Cdh (Degradation heating)					1.0		
B Condition (2°CDB/1°CWB)		COPd		2.24			2.20		2.17	
		Pdh	kW	9.0			10.1		9.8	
		PERd	%	89.6			88.0		86.8	
C Condition (7°CDB/6°CWB)		Cdh (Degradation heating)					1.0			
		COPd		3.74				3.83		
	Pdh	kW	6.2				7.6			
D Condition (12°CDB/11°CWB)	Cdh (Degradation heating)					1.0				
	COPd		5.68				5.69			
	Pdh	kW				5.0				
Average climate water outlet 35°C	General	PERd	%	227.2				227.6		
		Tbiv	°C	4					3	
		COPd		2.41			2.65		2.40	
		Pdh	kW	8.5			11.1		11.0	
		PERd	%	96.4			106.0		96.0	
	Average climate water outlet 35°C	General	Tbiv	°C			4			3
			Annual energy consumption	kWh	4,462			4,935		5,377
			ηs (Seasonal space heating efficiency)	%	182				181	
			Prated at -10°C	kW	10			11		12
			Qhe Annual energy consumption (GCV)	Gj	16			18		19
A Condition (7°CDB/-8°CWB)		SCOP		4.63			4.60		4.61	
		Seasonal space heating eff. class					A+++			
		COPd		3.03			2.99		2.87	
		Pdh	kW	9.2			9.8		11.2	
		PERd	%	121.2			119.6		114.8	
B Condition (2°CDB/1°CWB)	Cdh (Degradation heating)					1.0				
	COPd		4.37			4.35		4.33		
	Pdh	kW	5.5			6.1		6.7		

2 Specifications

1 - 1 ERLA11-16DW1

Technical specifications				EBSHB11P30D + ERLA11DW1	EBSHB11P50D + ERLA11DW1	EBSHB16P30D + ERLA14DW1	EBSHB16P50D + ERLA14DW1	EBSHB16P30D + ERLA16DW1	EBSHB16P50D + ERLA16DW1		
Space heating 	Average climate water outlet 35°C	B Condition (2°CDB/1°CWB)	PERd	%	174.8		174.0		173.2		
		C Condition (7°CDB/6°CWB)	Cdh (Degradation heating)				1.0				
			COPd		6.74		6.70		6.83		
			Pdh	kW		4.6		4.7			
			PERd	%	269.6		268.0		273.2		
			D Condition (12°CDB/11°CWB)	Cdh (Degradation heating)			1.0				
			COPd		8.54		8.65		8.82		
			Pdh	kW		5.4		5.5			
			PERd	%	341.6		346.0		352.8		
			Tol (temperature operating limit)	COPd		2.73		2.71		2.52	
				Pdh	kW	8.4		9.1		10.6	
				PERd	%	109.2		108.4		100.8	
				TOL	°C			-10			
				WTOL	°C			35			
				Tbiv (bivalent temperature)	COPd		3.01		2.99		2.72
					Pdh	kW	9.2		9.8		11.4
					PERd	%	120.4		119.6		108.8
					Tbiv	°C	-8		-7		-8
				Rated heat output supplementary capacity	Psup (at Tdesign -10°C)	kW	1.6		1.9		1.4
		Cold climate water outlet 35°C	General	Annual energy consumption	kWh	5,951		6,439		7,257	
ηs (Seasonal space heating efficiency)	%			163		165		160			
Prated at -22°C	kW			10		11		12			
Qhe Annual energy consumption (GCV)	Gj			21		23		26			
A Condition (-7°CDB/-8°CWB)	COPd			3.81		3.58		3.48			
	Pdh		kW	6.2		7.0		7.5			
	PERd		%	152.4		143.2		139.2			
B Condition (2°CDB/1°CWB)	Cdh (Degradation heating)					1.0					
	COPd			5.02		5.41		4.83			
	Pdh		kW	3.6		4.3		4.5			
C Condition (7°CDB/6°CWB)	Cdh (Degradation heating)					1.0					
	COPd			7.31		7.03		7.36			
	Pdh		kW	5.1		4.8		5.0			
D Condition (12°CDB/11°CWB)	Cdh (Degradation heating)					1.0					
	COPd			8.82		8.80		8.78			
	Pdh		kW	5.7		5.8		5.7			

2 Specifications

1 - 1 ERLA11-16DW1

2



Technical specifications					EBSHB11P30D + ERLA11DW1	EBSHB11P50D + ERLA11DW1	EBSHB16P30D + ERLA14DW1	EBSHB16P50D + ERLA14DW1	EBSHB16P30D + ERLA16DW1	EBSHB16P50D + ERLA16DW1		
Space heating	Cold climate water outlet 35°C	D Condition (12°CDB/11°CWB)	PERd	%	352.8		352.0		351.2			
			Tol (temperature operating limit)	COPd		2.24		2.23		2.14		
				Pdh	kW	6.8		7.3		9.2		
				PERd	%	89.6		89.2		85.6		
				TOL	°C			-20				
				WTOL	°C			34				
				G Condition (-15°CDB/-)	COPd		2.48		2.50		2.40	
					Pdh	kW	7.0		7.7		9.7	
					PERd	%	99.2		100.0		96.0	
				Tbiv (bivalent temperature)	COPd		2.62		2.81		2.40	
					Pdh	kW	7.3		8.7		9.7	
					PERd	%	104.8		112.4		96.0	
					Tbiv	°C			-12		-15	
				Rated heat output supplementary capacity	Psup (at Tdesign -22°C)	kW	2.7		3.2		2.2	
		Warm climate water outlet 35°C	General	Annual energy consumption (Seasonal space heating efficiency)	Prated at 2°C	kW	10		11		12	
Qhe Annual energy consumption (GCV)	Gj				8		9		10			
				B Condition (2°CDB/1°CWB)	Cdh (Degradation heating)				1.0			
					COPd		3.64		3.51		3.30	
					Pdh	kW	9.8		11.0		11.9	
					PERd	%	145.6		140.4		132.0	
				C Condition (7°CDB/6°CWB)	Cdh (Degradation heating)				1.0			
					COPd		5.70		5.77		5.64	
					Pdh	kW	6.7		7.4		8.1	
					PERd	%	228.0		230.8		225.6	
				Tbiv (bivalent temperature)	COPd		3.81		3.51		3.30	
					Pdh	kW	9.2		11.0		11.9	
					PERd	%	152.4		140.4		132.0	
			Tbiv	°C	3				2			
		D Condition (12°CDB/11°CWB)	Cdh (Degradation heating)				1.0					
			COPd		7.87		7.73					
			Pdh	kW			5.2					
			PERd	%	314.8		309.2					

(1)Condition 1: cooling Ta 35°C - LWE 18°C (DT = 5°C); heating Ta DB/WB 7°C/6°C - LWC 35°C (DT = 5°C) | Condition 2: cooling Ta 35°C - LWE 7°C (DT = 5°C); heating Ta DB/WB 7°C/6°C - LWC 45°C (DT = 5°C)

Technical specifications					EBSXB11P30D + ERLA11DW1	EBSXB11P50D + ERLA11DW1	EBSXB16P30D + ERLA14DW1	EBSXB16P50D + ERLA14DW1	EBSXB16P30D + ERLA16DW1	EBSXB16P50D + ERLA16DW1
Indoor unit					EBSXB11P30DF	EBSXB11P50DF	EBSXB16P30DF	EBSXB16P50DF	EBSXB16P30DF	EBSXB16P50DF
Outdoor unit					ERLA11DAW1		ERLA14DAW1		ERLA16DAW1	
Heating capacity	Nom.		kW	10.6 (1)		12.0 (1)		16.0 (1)		
Cooling capacity	Nom.		kW	11.2 (2)		12.9 (2)		13.6 (2)		
Power input	Heating	Nom.	kW	2.19 (1)		2.46 (1)		3.53 (1)		
	Cooling	Nom.	kW	3.47 (2)		4.34 (2)		4.68 (2)		
COP					4.83 (1)		4.87 (1)		4.53 (1)	
EER					3.22 (2)		2.98 (2)		2.91 (2)	
Pump					Grundfos UPM3L K 20-75 CHBL AZA 3 RT		Grundfos UPML 20-105 CHBL 3H RT			
Water side Heat exchanger	Water flow rate	Cooling	Nom.	l/min	32.1 (2)		37.1 (2)		39.1 (2)	
		Heating	Nom.	l/min	30.3 (1)		34.4 (1)		45.9 (1)	

2 Specifications

1 - 1 ERLA11-16DW1

Technical specifications			EBSXB11P30D + ERLA11DW1	EBSXB11P50D + ERLA11DW1	EBSXB16P30D + ERLA14DW1	EBSXB16P50D + ERLA14DW1	EBSXB16P30D + ERLA16DW1	EBSXB16P50D + ERLA16DW1	
General	Supplier/Manu- facturer details	Name and address	Daikin Europe N.V. - Zandvoordestraat 300, 8400 Oostende, Belgium						
		Name or trademark	Daikin Europe N.V.						
	Product descrip- tion	Air-to-water heat pump		Yes					
		Brine-to-water heat pump		No					
		Heat pump combination heater		Yes					
		Low-temperature heat pump		No					
		Supplementary heater integrated		No					
	LW(A) Sound power level (according to EN14825)	Indoor	dB(A)	44.7			49.0		
		Outdoor	dB(A)	62.0					
	LW(A) Sound power level (according to EN14825)			Sound power in heating mode, measured according to the EN12102 under conditions of the EN14825					
Space heating general	Air to water unit	Rated airflow (outdoor)	3,350		4,220		5,100		
	Other	Capacity control	Inverter						
		Pck (Crankcase heater mode) kW	0.000						
		Poff (Off mode) kW	0.023						
		Psb (Standby mode) kW	0.023						
Pto (Thermostat off) kW	0.023								
Domestic hot water heating 	General	Declared load profile	L	XL	L	XL	L	XL	
		Function to fix water heating during off peak hours	No						
	Average climate	AEC (Annual electricity consumption)	kWh	887	1,313	887	1,313	887	1,313
		COPdhw		2.75	3.10	2.75	3.10	2.75	3.10
		Heat up time		1h 39min	2h 34min	1h 39min	2h 34min	1h 39min	2h 34min
		Mixed water at 40°C	l	196.0	242.0	196.0	242.0	196.0	242.0
		η _{wh} (water heating efficiency)	%	116	128	116	128	116	128
		Qelec (Daily electricity consumption)	kWh	4.236	6.149	4.236	6.149	4.236	6.149
		Reference hot water temperature	°C	46.9	44.1	46.9	44.1	46.9	44.1
	Domestic hot water heating 	Average climate	Stand-by power input	W	35.6	31.4	35.6	31.4	35.6
Water heating energy efficiency class				A+					
Cold climate		AEC (Annual electricity consumption)	kWh	1,051	1,526	1,051	1,526	1,051	1,526
		COPdhw		2.33	2.67	2.33	2.67	2.33	2.67
		Heat up time		1h 57min	2h 31min	1h 57min	2h 31min	1h 57min	2h 31min
		Mixed water at 40°C	l	196.0	242.0	196.0	242.0	196.0	242.0
		η _{wh} (water heating efficiency)	%	98	110	98	110	98	110
		Qelec (Daily electricity consumption)	kWh	4.996	7.137	4.996	7.137	4.996	7.137
		Reference hot water temperature	°C	46.9	44.1	46.9	44.1	46.9	44.1
Warm climate		Stand-by power input	W	38.5	34.4	38.5	34.4	38.5	34.4
	AEC (Annual electricity consumption)	kWh	750	1,078	750	1,078	750	1,078	
	COPdhw		3.24	3.76	3.24	3.76	3.24	3.76	
	Heat up time		1h 45min	2h 49min	1h 45min	2h 49min	1h 45min	2h 49min	
	Mixed water at 40°C	l	196.0	242.0	196.0	242.0	196.0	242.0	
	η _{wh} (water heating efficiency)	%	137	155	137	155	137	155	
	Qelec (Daily electricity consumption)	kWh	3.604	5.073	3.604	5.073	3.604	5.073	
Reference hot water temperature	°C	46.9	44.1	46.9	44.1	46.9	44.1		
	Stand-by power input	W	34.5	30.5	34.5	30.5	34.5	30.5	

2 Specifications

1 - 1 ERLA11-16DW1

2

Technical specifications				EBSXB11P30D + ERLA11DW1	EBSXB11P50D + ERLA11DW1	EBSXB16P30D + ERLA14DW1	EBSXB16P50D + ERLA14DW1	EBSXB16P30D + ERLA16DW1	EBSXB16P50D + ERLA16DW1				
Space heating	Average climate water outlet 55°C	General	Annual energy consumption	kWh	6,312		6,962		7,392				
			ηs (Seasonal space heating efficiency)	%	128				131				
			Prated at -10°C	kW	10		11		12				
			Qhe Annual energy consumption (GCV)	Gj	23		25		27				
			SCOP		3.27		3.26		3.35				
			Seasonal space heating eff. class				A++						
			A Condition (-7°CDB/-8°CWB)	Cdh (Degradation heating)				1.0					
				COPd		1.89		1.80		1.95			
				Pdh	kW	7.9		8.5		9.4			
				PERd	%	75.6		72.0		78.0			
			B Condition (2°CDB/-1°CWB)	Cdh (Degradation heating)				1.0					
				COPd		3.25		3.28		3.27			
				Pdh	kW	5.4		6.2		6.9			
			C Condition (7°CDB/6°CWB)	Cdh (Degradation heating)				1.0					
				COPd		4.81		4.88		4.93			
				Pdh	kW	192.4		195.2		197.2			
			Space heating	Average climate water outlet 55°C	D Condition (12°CDB/11°CWB)	Cdh (Degradation heating)				1.0			
						COPd		6.41		6.58		6.60	
						Pdh	kW	256.4		263.2		264.0	
						PERd	%	1.68		1.76		1.50	
Tol (temperature operating limit)	Pdh	kW				6.8		7.0		6.0			
	PERd	%				67.2		70.4		60.0			
	TOL	°C						-10					
Rated heat output supplementary capacity	WTOL	°C						55					
	Psup (at Tdesign -10°C)	kW				3.2		4.0		6.1			
Tbiv (bivalent temperature)	COPd					1.96		1.87		2.13			
	Pdh	kW				8.2		8.9		10.1			
	PERd	%				78.4		74.8		85.2			
	Tbiv	°C						-5					
Cold climate water outlet 55°C	General	Annual energy consumption				kWh	8,031		8,974		9,510		
		ηs (Seasonal space heating efficiency)				%	120		118		121		
		Prated at -22°C				kW	10		11		12		
		Qhe Annual energy consumption (GCV)				Gj	29		32		34		
		A Condition (-7°CDB/-8°CWB)				Cdh (Degradation heating)				1.0			
						COPd		2.65		2.63		2.64	
						Pdh	kW	6.3		7.0		7.3	
			PERd	%	106.0		105.2		105.6				
		B Condition (2°CDB/1°CWB)	Cdh (Degradation heating)				1.0						
			COPd		4.12		3.96		3.98				
			Pdh	kW	3.9		4.4		4.5				
		C Condition (7°CDB/6°CWB)	Cdh (Degradation heating)				1.0						
			COPd		5.14		5.21		5.39				
			Pdh	kW	205.6		208.4		215.6				
		D Condition (12°CDB/11°CWB)	COPd		6.88		6.62		6.26				
			Pdh	kW			5.4		5.0				
			PERd	%	275.2		264.8		250.4				
		Tol (temperature operating limit)	COPd		1.84		1.81		2.06				
			Pdh	kW	7.5		8.0		9.7				
			PERd	%	73.6		72.4		82.4				
TOL	°C			-15									

2 Specifications

1 - 1 ERLA11-16DW1

Technical specifications				EBSXB11P30D + ERLA11DW1	EBSXB11P50D + ERLA11DW1	EBSXB16P30D + ERLA14DW1	EBSXB16P50D + ERLA14DW1	EBSXB16P30D + ERLA16DW1	EBSXB16P50D + ERLA16DW1
Space heating 	Cold climate water outlet 55°C	Tol (temperature operating limit)	WTOL °C	49					
		G Condition (-15°CDB/-)	COPd		1.84		1.81		2.06
			Pdh	kW	7.5		8.0		9.7
			PERd	%	73.6		72.4		82.4
		(bivalent temperature)	Tbiv	COPd	1.88		2.02		2.06
			Pdh	kW	7.1		7.8		9.7
			PERd	%	75.2		80.8		82.4
		Rated heat output supplementary capacity	Tbiv	°C	-12		-11		-15
			Psup (at Tdesign -22°C)	kW	0.6		1.0		0.0
		Warm climate water outlet 55°C	General	Annual energy consumption	kWh	3,157		3,717	
ηs (Seasonal space heating efficiency)	%			166		171		172	
Prated at 2°C	kW			10			12.1		
Qhe Annual energy consumption (GCV)	Gj			11			13		
Cdh (Degradation heating)						1.0			
B Condition (2°CDB/1°CWB)	COPd			2.24		2.20		2.17	
	Pdh		kW	9.0		10.1		9.8	
	PERd		%	89.6		88.0		86.8	
C Condition (7°CDB/6°CWB)	Cdh (Degradation heating)					1.0			
	COPd			3.74			3.83		
	Pdh		kW	6.2			7.6		
D Condition (12°CDB/11°CWB)	Cdh (Degradation heating)					1.0			
	COPd			5.68			5.69		
	Pdh		kW			5.0			
(bivalent temperature)	PERd		%	227.2			227.6		
	Tbiv	COPd	2.41		2.65		2.40		
	Pdh	kW	8.5		11.1		11.0		
Average climate water outlet 35°C	General	PERd	%	96.4		106.0		96.0	
		Tbiv	°C		4			3	
		Annual energy consumption	kWh	4,378		4,851		5,293	
A Condition (-7°CDB/-8°CWB)	General	ηs (Seasonal space heating efficiency)	%	186			184		
		Prated at -10°C	kW	10		11		12	
		Qhe Annual energy consumption (GCV)	Gj	16		17		19	
		SCOP		4.72			4.68		
		Seasonal space heating eff. class				A+++			
		COPd		3.03		2.99		2.87	
		Pdh	kW	9.2		9.8		11.2	

2 Specifications

1 - 1 ERLA11-16DW1

2

Technical specifications				EBSXB11P30D + ERLA11DW1	EBSXB11P50D + ERLA11DW1	EBSXB16P30D + ERLA14DW1	EBSXB16P50D + ERLA14DW1	EBSXB16P30D + ERLA16DW1	EBSXB16P50D + ERLA16DW1	
Space heating Average climate water outlet 35°C	A Condition (7°CDB/-8°CWB)	PERd	%	121.2		119.6		114.8		
		Cd _h (Degradation heating)				1.0				
	B Con- dition (2°CDB- B/1°CWB)	COPd		4.37		4.35		4.33		
		Pd _h	kW	5.5		6.1		6.7		
		PERd	%	174.8		174.0		173.2		
	C Con- dition (7°CDB- B/6°CWB)	Cd _h (Degradation heating)				1.0				
		COPd		6.74		6.70		6.83		
		Pd _h	kW		4.6			4.7		
	D Condition (12°CDB/11°CWB)	Cd _h (Degradation heating)				1.0				
		COPd		8.54		8.65		8.82		
		Pd _h	kW		5.4			5.5		
	Tol (tem- perature operat- ing limit)	COPd			2.73		2.71		2.52	
		Pd _h	kW	8.4		9.1		10.6		
		PERd	%	109.2		108.4		100.8		
		TOL	°C			-10				
	Tbiv (bivalent tempera- ture)	COPd			3.01		2.99		2.72	
		Pd _h	kW	9.2		9.8		11.4		
		PERd	%	120.4		119.6		108.8		
		Tbiv	°C	-8		-7		-8		
	Rated heat output supple- mentary capacity	P _{sup} (at T _{design} -10°C)		kW	1.6		1.9		1.4	
Cold climate water outlet 35°C	General	Annual energy consumption	kWh	5,901		6,388		7,206		
		η _s (Seasonal space heating efficiency)	%	164		167		161		
		Prated at -22°C	kW	10		11		12		
		Q _{he} Annual ener- gy consumption (GCV)	Gj	21		23		26		
	A Condition (7°CDB/-8°CWB)	COPd			3.81		3.58		3.48	
		Pd _h	kW	6.2		7.0		7.5		
		PERd	%	152.4		143.2		139.2		
	B Con- dition (2°CDB- B/1°CWB)	Cd _h (Degradation heating)				1.0				
		COPd		5.02		5.41		4.83		
		Pd _h	kW	3.6		4.3		4.5		
	C Condition (7°CDB/6°CWB)	Cd _h (Degradation heating)				1.0				
		COPd		7.31		7.03		7.36		
		Pd _h	kW	5.1		4.8		5.0		

2 Specifications

1 - 1 ERLA11-16DW1

Technical specifications					EBSXB11P30D + ERLA11DW1	EBSXB11P50D + ERLA11DW1	EBSXB16P30D + ERLA14DW1	EBSXB16P50D + ERLA14DW1	EBSXB16P30D + ERLA16DW1	EBSXB16P50D + ERLA16DW1
Space heating 	Cold climate water outlet 35°C	C Condition (7°CDB- B/6°CWB)	PERd	%	292.4		281.2		294.4	
			D Condition (12°CDB/11°CWB)		Cdh (Degradation heating)		1.0			
			COPd			8.82		8.80		8.78
			Pdh	kW		5.7		5.8		5.7
			PERd	%		352.8		352.0		351.2
		Tol (temperature operating limit)		COPd		2.24		2.23		2.14
				Pdh	kW	6.8		7.3		9.2
				PERd	%	89.6		89.2		85.6
				TOL	°C			-20		
			WTOL	°C			34			
	G Condition (-15°CDB/-)		COPd		2.48		2.50		2.40	
			Pdh	kW	7.0		7.7		9.7	
			PERd	%	99.2		100.0		96.0	
	Tbiv (bivalent temperature)		COPd		2.62		2.81		2.40	
			Pdh	kW	7.3		8.7		9.7	
			PERd	%	104.8		112.4		96.0	
			Tbiv	°C			-12		-15	
	Rated heat output supplementary capacity		Psup (at Tdesign -22°C)	kW	2.7		3.2		2.2	
	Warm climate water outlet 35°C	General	Annual energy consumption	kWh	2,126		2,330		2,573	
ηs (Seasonal space heating efficiency)			%	248		249		246		
Prated at 2°C			kW	10		11		12		
Qhe Annual energy consumption (GCV)			Gj		8		9			
B Condition (2°CDB- B/1°CWB)			Cdh (Degradation heating)				1.0			
			COPd		3.64		3.51		3.30	
		Pdh	kW	9.8		11.0		11.9		
		PERd	%	145.6		140.4		132.0		
C Condition (7°CDB- B/6°CWB)			Cdh (Degradation heating)				1.0			
			COPd		5.70		5.77		5.64	
		Pdh	kW	6.7		7.4		8.1		
		PERd	%	228.0		230.8		225.6		
Tbiv (bivalent temperature)		COPd		3.81		3.51		3.30		
		Pdh	kW	9.2		11.0		11.9		
		PERd	%	152.4		140.4		132.0		
		Tbiv	°C	3			2			
D Condition (12°CDB/11°CWB)		Cdh (Degradation heating)				1.0				
		COPd		7.87			7.73			
		Pdh	kW			5.2				
Space heating 	Warm climate water outlet 35°C	D Condition (12°CDB/11°CWB)	PERd	%	314.8			309.2		

(1)Condition 1: cooling Ta 35°C - LWE 18°C (DT = 5°C); heating Ta DB/WB 7°C/6°C - LWC 35°C (DT = 5°C) |
 (2)Condition 2: cooling Ta 35°C - LWE 7°C (DT = 5°C); heating Ta DB/WB 7°C/6°C - LWC 45°C (DT = 5°C)

Technical specifications				EBVX11S18D6V + ERLA11DW1	EBVX11S23D6V + ERLA11DW1	EBVX16S18D6V + ERLA14DW1	EBVX16S23D6V + ERLA14DW1	EBVX16S18D6V + ERLA16DW1	EBVX16S23D6V + ERLA16DW1
SEER				5.92 (5)		5.89 (5)		5.76 (5)	
Heating capacity	Nom.	kW		10.6 (1) / 9.82 (2)		12.0 (1) / 12.5 (2)		16.0 (1) / 16.0 (2)	
Cooling capacity	Nom.	kW		11.2 (3) / 12.0 (4)		13.1 (3) / 13.3 (4)		13.8 (3) / 15.9 (4)	
Power input	Heating	Nom.	kW	2.18 (1) / 2.68 (2)		2.46 (1) / 3.42 (2)		3.53 (1) / 4.56 (2)	
	Cooling	Nom.	kW	3.43 (3) / 2.52 (4)		4.32 (3) / 2.86 (4)		4.68 (3) / 3.82 (4)	
	Domestic hot water from 10°C to 50°C	Nom.	kWh	2.44	3.41	2.44	3.41	2.44	3.41

2 Specifications

1 - 1 ERLA11-16DW1

2

Technical specifications				EBVX11S18D6V + ERLA11DW1	EBVX11S23D6V + ERLA11DW1	EBVX16S18D6V + ERLA14DW1	EBVX16S23D6V + ERLA14DW1	EBVX16S18D6V + ERLA16DW1	EBVX16S23D6V + ERLA16DW1
Heat up time from 10°C to 50°C		hr		1h15min at 7°C ambient temperature	1h07min at 7°C ambient temperature	1h15min at 7°C ambient temperature	1h07min at 7°C ambient temperature	1h15min at 7°C ambient temperature	1h07min at 7°C ambient temperature
COP				4.83 (1) / 3.66 (2)		4.87 (1) / 3.64 (2)		4.53 (1) / 3.51 (2)	
EER				3.26 (3) / 4.75 (4)		3.02 (3) / 4.66 (4)		2.94 (3) / 4.16 (4)	
Pump	Nominal	Cooling	kPa	36.2 (6) / 39.6 (7)		59.9 (6) / 60.2 (7)		39.7 (6) / 53.5 (7)	
	ESP unit	Heating	kPa	46.9 (6) / 48.3 (7)		66.3 (6) / 62.9 (7)		33.7 (6) / 33.7 (7)	
Water side Heat exchanger	Water	Cooling Nom.	l/min	33.5 (6) / 32.2 (7)		37.3 (6) / 37.2 (7)		44.3 (6) / 39.7 (7)	
	flow rate	Heating Nom.	l/min	29.3 (6) / 28.7 (7)		34.7 (6) / 36.1 (7)		46.1 (6) / 46.1 (7)	
General	Supplier/	Name and address		Daikin Europe N.V. - Zandvoordestraat 300, 8400 Oostende, Belgium					
	Manu- facturer details	Name or trademark		Daikin Europe N.V.					
Product descrip- tion	Air-to-water heat pump			Yes					
	Brine-to-water heat pump			No					
	Heat pump combination heater			Yes					
	Low-temperature heat pump			No					
	Supplementary heater integrated			Yes					
LW(A) Sound power level (according to EN14825)	Indoor	dB(A)		44.0 (8)					
	Outdoor	dB(A)		62.0					
Sound condition Ecodesign and energy label				Sound power in heating mode, measured according to the EN12102 under conditions of the EN14825					
Space heating general	Air to water unit	Rated airflow (outdoor)	m ³ /h	3,350		4,220		5,100	
	Other	Capacity control		Inverter					
		Pck (Crankcase heater mode)	kW	0.000					
		Poff (Off mode)	kW	0.023					
		Psb (Standby mode)	kW	0.023					
Pto (Thermostat off)	kW	0.023							
Domestic hot water heating	General	Declared load profile		L	XL	L	XL	L	XL
		Function to fix water heating during off peak hours		No					
Space heating general	Inte- grated supple- mentary heater	Psup	kW	6.0					
		Type of energy input		Electrical					
Domestic hot water heating	Average climate	AEC (Annual electricity consumption)	kWh	886	1,542	886	1,542	886	1,542
		COPdhw		2.73	2.63	2.73	2.63	2.73	2.63

2 Specifications

1 - 1 ERLA11-16DW1

Technical specifications			EBVX11S18D6V + ERLA11DW1	EBVX11S23D6V + ERLA11DW1	EBVX16S18D6V + ERLA14DW1	EBVX16S23D6V + ERLA14DW1	EBVX16S18D6V + ERLA16DW1	EBVX16S23D6V + ERLA16DW1				
Domestic hot water heating	Average climate	Heat up time	1h 21min	1h 11min	1h 21min	1h 11min	1h 21min	1h 11min				
		Mixed water at 40°C	l	244.0	295.0	244.0	295.0	244.0	295.0			
		η _{wh} (water heating efficiency)	%	116	109	116	109	116	109			
		Qelec (Daily electricity consumption)	kWh	4.260	7.260	4.260	7.260	4.260	7.260			
		Reference hot water temperature	°C	52.7	51.5	52.7	51.5	52.7	51.5			
		Stand-by power input	W	42.0	43.2	42.0	43.2	42.0	43.2			
		Water heating energy efficiency class		A+	A	A+	A	A+	A			
		AEC (Annual electricity consumption)	kWh	1,087	1,963	1,087	1,963	1,087	1,963			
	Cold climate	COP _{dhw}		2.24	2.08	2.24	2.08	2.24	2.08			
		η _{wh} (water heating efficiency)	%	94	85	94	85	94	85			
		Qelec (Daily electricity consumption)	kWh	5.200	9.180	5.200	9.180	5.200	9.180			
		Stand-by power input	W	45.9	43.1	45.9	43.1	45.9	43.1			
	Warm climate	AEC (Annual electricity consumption)	kWh	737	1,349	737	1,349	737	1,349			
		COP _{dhw}		3.26	3.00	3.26	3.00	3.26	3.00			
		Heat up time		1h 16min	1h 10min	1h 16min	1h 10min	1h 16min	1h 10min			
		Mixed water at 40°C	l	244.0	295.0	244.0	295.0	244.0	295.0			
η _{wh} (water heating efficiency)		%	139	124	139	124	139	124				
Qelec (Daily electricity consumption)		kWh	3.570	6.350	3.570	6.350	3.570	6.350				
Reference hot water temperature		°C	52.7	51.5	52.7	51.5	52.7	51.5				
Stand-by power input		W	38.4	37.6	38.4	37.6	38.4	37.6				
Space heating	Average climate water outlet 55°C	General	Annual energy consumption	kWh	6,312		6,962		7,392			
			η _s (Seasonal space heating efficiency)	%	128				131			
		Prated at -10°C	Q _{he} Annual energy consumption (GCV)	Gj	10		23		11		27	
			SCOP		3.27		3.26		3.26		3.35	
		Seasonal space heating eff. class			A++							
		A Condition (-7°CDB/-8°CWB)	Cd _h (Degradation heating)		1.0							
			COP _d		1.89		1.80		1.95			
			Pd _h	kW	7.9		8.5		9.4			
		B Condition (2°CDB/1°CWB)	Cd _h (Degradation heating)		1.0							
			COP _d		3.25		3.28		3.27			
			Pd _h	kW	5.4		6.2		6.9			
		C Condition (7°CDB/6°CWB)	Cd _h (Degradation heating)		1.0							
			COP _d		4.81		4.88		4.93			
			Pd _h	kW	4.81		4.88		4.93			

2 Specifications

1 - 1 ERLA11-16DW1

2

Technical specifications				EBVX11S18D6V + ERLA11DW1	EBVX11S23D6V + ERLA11DW1	EBVX16S18D6V + ERLA14DW1	EBVX16S23D6V + ERLA14DW1	EBVX16S18D6V + ERLA16DW1	EBVX16S23D6V + ERLA16DW1	
Space heating	Average climate water outlet 55°C	C Condition (7°CDB/6°CWB)	PERd	%	192.4		195.2		197.2	
		D Condition (12°CDB/11°CWB)	CdH (Degradation heating)					1.0		
			COPd		6.41		6.58		6.60	
			Pdh	kW			5.3			
		Tol (temperature operating limit)	PERd	%	256.4		263.2		264.0	
			COPd		1.68		1.76		1.50	
			Pdh	kW	6.8		7.0		6.0	
		Rated heat output supplementary capacity	PERd	%	67.2		70.4		60.0	
			TOL	°C			-10			
			WTOL	°C			55			
		Tbiv (bivalent temperature)	Psup (at Tdesign -10°C)	kW	3.2		4.0		6.1	
			Tbiv	COPd	1.96		1.87		2.13	
			Pdh	kW	8.2		8.9		10.1	
		Cold climate water outlet 55°C	General	PERd	%	78.4		74.8		85.2
				Tbiv	°C			-5		
				Annual energy consumption	kWh	8,031		8,974		9,510
				ηs (Seasonal space heating efficiency)	%	120		118		121
				Prated at -22°C	kW	10		11		12
Warm climate water outlet 55°C	General	Qhe Annual energy consumption (GCV)	Gj	29		32		34		
		Annual energy consumption	kWh	3,157		3,717		3,690		
		ηs (Seasonal space heating efficiency)	%	166		171		172		
		Prated at 2°C	kW	10			12.1			
		Qhe Annual energy consumption (GCV)	Gj	11			13			
B Condition (2°CDB/1°CWB)	CdH (Degradation heating)					1.0				
	COPd		2.24		2.20		2.17			
	Pdh	kW	9.0		10.1		9.8			
C Condition (7°CDB/6°CWB)	PERd	%	89.6		88.0		86.8			
	CdH (Degradation heating)					1.0				
	COPd		3.74			3.83				
D Condition (12°CDB/11°CWB)	Pdh	kW	6.2			7.6				
	PERd	%	149.6			153.2				
	CdH (Degradation heating)					1.0				
Tbiv (bivalent temperature)	COPd		5.68			5.69				
	Pdh	kW			5.0					
	PERd	%	227.2			227.6				
Tbiv (bivalent temperature)	COPd		2.41		2.65		2.40			
	Pdh	kW	8.5		11.1		11.0			

2 Specifications

1 - 1 ERLA11-16DW1

Technical specifications					EBVX11S18D6V + ERLA11DW1	EBVX11S23D6V + ERLA11DW1	EBVX16S18D6V + ERLA14DW1	EBVX16S23D6V + ERLA14DW1	EBVX16S18D6V + ERLA16DW1	EBVX16S23D6V + ERLA16DW1	
Space heating 	Warm climate water outlet 55°C	Tbiv	PERd	%	96.4		106.0		96.0		
		(bivalent temperature)	Tbiv	°C		4			3		
	Average climate water outlet 35°C	General	Annual energy consumption	kWh		4,378		4,851		5,293	
			ηs (Seasonal space heating efficiency)	%		186		184			
		Prated at -10°C	kW		10		11		12		
		Qhe Annual energy consumption (GCV)	Gj		16		17		19		
		SCOP			4.72		4.68				
		Seasonal space heating eff. class					A+++				
		A Condition (-7°CDB/-8°CWB)	COPd			3.03		2.99		2.87	
			Pdh	kW		9.2		9.8		11.2	
			PERd	%		121.2		119.6		114.8	
		B Condition (2°CDB/1°CWB)	Cdhd (Degradation heating)					1.0			
	COPd				4.37		4.35		4.33		
	Pdh		kW		5.5		6.1		6.7		
	C Condition (7°CDB/6°CWB)	Cdhd (Degradation heating)					1.0				
		COPd			6.74		6.70		6.83		
		Pdh	kW			4.6		4.7			
	D Condition (12°CDB/11°CWB)	Cdhd (Degradation heating)					1.0				
		COPd			8.54		8.65		8.82		
		Pdh	kW			5.4		5.5			
Tol (temperature operating limit)	COPd			341.6		346.0		352.8			
	Pdh	kW		2.73		2.71		2.52			
	Pdh	kW		8.4		9.1		10.6			
	PERd	%		109.2		108.4		100.8			
	TOL	°C				-10					
Tbiv (bivalent temperature)	WTOL	°C				35					
	COPd			3.01		2.99		2.72			
	Pdh	kW		9.2		9.8		11.4			
	PERd	%		120.4		119.6		108.8			
	Tbiv	°C		-8		-7		-8			
Rated heat output supplementary capacity	Psup (at Tdesign -10°C)	kW		1.6		1.9		1.4			
Cold climate water outlet 35°C	General	Annual energy consumption	kWh		5,901		6,388		7,206		
		ηs (Seasonal space heating efficiency)	%		164		167		161		
	Prated at -22°C	kW		10		11		12			
	Qhe Annual energy consumption (GCV)	Gj		21		23		26			

2 Specifications

1 - 1 ERLA11-16DW1

2

Technical specifications				EBVX11S18D6V + ERLA11DW1	EBVX11S23D6V + ERLA11DW1	EBVX16S18D6V + ERLA14DW1	EBVX16S23D6V + ERLA14DW1	EBVX16S18D6V + ERLA16DW1	EBVX16S23D6V + ERLA16DW1	
Space heating	Warm climate water outlet 35°C	General	Annual energy consumption	kWh	2,126		2,330		2,573	
			ηs (Seasonal space heating efficiency)	%	248		249		246	
			Prated at 2°C	kW	10		11		12	
			Qhe Annual energy consumption (GCV)	Gj		8			9	
			B Condition (2°CDB-B/1°CWB)	Cdh (Degradation heating)				1.0		
				COPd		3.64		3.51		3.30
				Pdh	kW	9.8		11.0		11.9
				PERd	%	145.6		140.4		132.0
			C Condition (7°CDB-B/6°CWB)	Cdh (Degradation heating)				1.0		
				COPd		5.70		5.77		5.64
				Pdh	kW	6.7		7.4		8.1
				PERd	%	228.0		230.8		225.6
			Tbiv (bivalent temperature)	COPd		3.81		3.51		3.30
				Pdh	kW	9.2		11.0		11.9
				PERd	%	152.4		140.4		132.0
				Tbiv	°C	3			2	
			D Condition (12°CDB/11°CWB)	Cdh (Degradation heating)				1.0		
				COPd		7.87			7.73	
				Pdh	kW			5.2		
				PERd	%	314.8			309.2	

(1)Condition: Ta DB/WB 7°C/6°C - LWC 35°C (DT = 5°C) |

(2)Condition: Ta DB/WB 7°C/6°C - LWC 45°C (DT=5°C) |

(3)Cooling: EW 12°C; LW 7°C; ambient conditions: 35°CDB |

(4)Cooling: EW 23°C; LW 18°C; ambient conditions: 35°CDB |

(5)According to EN14825 |

(6)Condition 1: cooling Ta 35°C - LWE 18°C (DT = 5°C); heating Ta DB/WB 7°C/6°C - LWC 35°C (DT = 5°C) |

(7)Condition 2: cooling Ta 35°C - LWE 7°C (DT = 5°C); heating Ta DB/WB 7°C/6°C - LWC 45°C (DT = 5°C) |

(8)Measured with a pressure drop of 10 kPa in the heating system at an operating condition of leaving water 47-55°C in a room with an ambient of 20°C. DB/WB 7°C/6°.

Technical Specifications				ERLA11DW1	ERLA14DW1	ERLA16DW1	
Casing	Colour	Ivory white					
	Material	Polyester painted galvanised steel plate					
Dimensions	Unit	Height	mm	870			
		Width	mm	1,100			
		Depth	mm	460			
	Packed unit	Height	mm	1,118			
		Width	mm	1,207			
		Depth	mm	682			
Weight	Unit	kg	101				
	Packed unit	kg	120				
Packing	Material	Carton + Wood + EPS					
	Weight	kg	18				
Heat exchanger	Length	mm	1,195				
	Rows	Quantity	3				
	Fin pitch	mm	1.40				
	Passes	Quantity	13				
	Face area	m ²	0.950 / 0.970 / 1.00				
	Stages	Quantity	38				
	Empty tubeplate hole	Quantity	2				
	Tube type	ø7 Hi-XSL					
	Fin	Type	WF fin				
		Treatment	Anti-corrosion treatment (PE)				
	Fan	Type	Propeller fan				
		Quantity	1				
Air flow rate		Heating High	m ³ /min	55.8	70.4	85.0	
		Cooling High	m ³ /min	70.4		85.0	
Fan motor	Discharge direction	Horizontal					
	Quantity	1					
	Model	Brushless DC motor					
	Output	W	234				
	Drive	Direct drive					
	Speed	Steps	8				
		Heating Nom.	rpm	450	550	650	
		Cooling Nom.	rpm		650		
Compressor	Quantity	1					
	Model	2Y350BPAY1P#C					

2 Specifications

1 - 1 ERLA11-16DW1

Technical Specifications				ERLA11DW1	ERLA14DW1	ERLA16DW1	
Compressor	Type	Hermetically sealed swing inverter compressor					
	Starting method	Inverter driven					
PED	Category	Category II					
Operation range	Heating	Min.	°CDB	-25.0			
		Max.	°CDB	25 (1) / 35 (1)			
	Cooling	Min.	°CDB	10			
		Max.	°CDB	43			
	Domestic hot water	Max.	°CDB	25 (1) / 35 (1)			
	Min.	°CDB	-25				
PED	Most critical part	Name		Accumulator			
		P _s *V	Bar*l	159			
Sound power level	Heating	Nom.	dBa	62.0 (2)			
Sound pressure level	Heating	Nom.	dBa	48.0 (2)			
Refrigerant	Type	R-32					
	GWP	675.0					
	Charge	TCO ₂ Eq			2.57		
	Charge	kg			3.80		
	Control	Electronic expansion valve					
Refrigerant oil	Circuits	Quantity	1				
	Type	FW68DA					
Piping connections	Liquid	Charged volume	l	1.4			
		Quantity	1				
	Gas	Type	Flare connection				
		OD	mm	9.50			
		Quantity	1				
	Drain	Type	Flare connection				
		OD	mm	15.9			
		Quantity	8				
	Piping length	OU - IU	Min.	m	3		
			Max.	m	50		
		System	Chargeless	m	10		
	High pressure side	Design pressure	bar	42			
	Additional refrigerant charge	kg/m	0.05 (for piping length exceeding 10m)				
	Level difference	IU - OU	Max.	m	30.0		
	Heat insulation	Both liquid and gas pipes					
Defrost control	Sensor for outdoor heat exchanger temperature						
Defrost method	Reversed cycle						
Capacity control	Method	Variable (inverter)					
Safety devices	Item	01	High pressure switch				
		02	Low pressure switch				
		03	Fan driver overload protector				
		04	Fuse				
		05	Compressor motor thermal protector				
Electrical Specifications				ERLA11DW1	ERLA14DW1	ERLA16DW1	
Power supply	Name	W1					
	Phase	3~					
	Frequency	Hz	50				
	Voltage	V	400				
	Voltage range	Min.	%	-10			
Max.		%	10				
Current	Maximum running current	Heating	A	14.0			
		Cooling	A	14.0			
	Recommended fuses	A	16				
Wiring connections	For power supply	Quantity	5				
		Remark	Select diameter and type according to national and local regulations				
	For connection with indoor	Quantity	4				
		Remark	1,5mm ²				
IP class	IP	IPX4					

(1)For more details, see operation range drawing |

(2)Measured with a pressure drop of 10 kPa in the heating system at an operating condition of leaving water 47-55°C in a room with an ambient of 20°C. DB/WB 7°C/6°.

3 Combination table

3 - 1 Combination Table

3
ERLA11-16DV3
ERLA11-16DW1
Combination table

Description	ERLA11DAV3	ERLA14DAV3	ERLA16DAV3	ERLA11DAW1	ERLA14DAW1	ERLA16DAW1
EBBH11DF*	Heating only indoor unit	o	---	---	o	---
EBBX11DF*	Reversible indoor unit	o	---	---	o	---
EBBH16DF*	Heating only indoor unit	---	o	o	---	o
EBBX16DF*	Reversible indoor unit	---	o	o	---	o

Description	ERLA11DAV3/W1	ERLA14DAV3/W1	ERLA16DAV3/W1
EBVH11S(18/23)DJ*	Heating only indoor unit	o	-
EBVX11S(18/23)DJ*	Reversible indoor unit	o	-
EBVH16S(18/23)DJ*	Heating only indoor unit	-	o
EBVX16S(18/23)DJ*	Reversible indoor unit	-	o
EBVZ16S(18/23)DJ*	(Integrated Bizone)	o	o
EBVH16SU(18/23)DJ6V	Heating only indoor unit for the UK	o	o

Remark Other combinations than mentioned in this combination table are prohibited.

3D136861

4 Capacity graphs

4 - 1 Cooling Capacity Graphs

ERLA11-16DV3

ERLA11-16DW1 Maximum cooling capacity

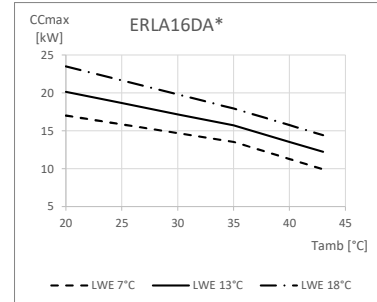
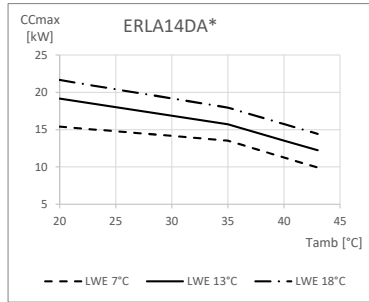
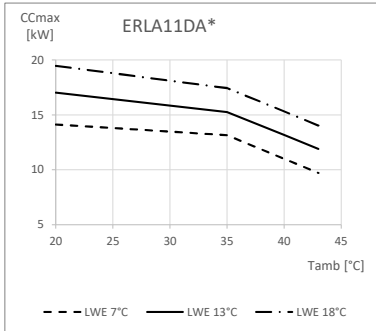

Symbols

CC_{max} Cooling capacity at maximum operating frequency, measured according to EN 14511.

LWE Leaving water evaporator temperature [°C]

Tamb Ambient temperature [°C DB]

Conditions

Cooling capacity

Capacity according to standard EN 14511 and valid for chilled water range ΔT = 3~8°C.

Notes

The capacity and power input is valid for ·V3· models at ·230·V and for for ·W1· models at ·400·V.

The capacity and the power input are at maximum operation.

4D137188

4 Capacity graphs

4 - 2 Heating Capacity Graphs

4

ERLA11-16DV3

ERLA11-16DW1

Maximum heating capacity - integrated value

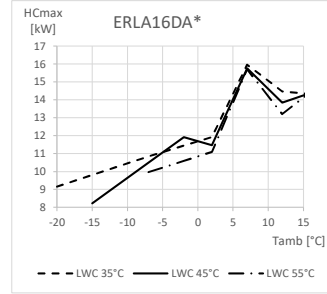
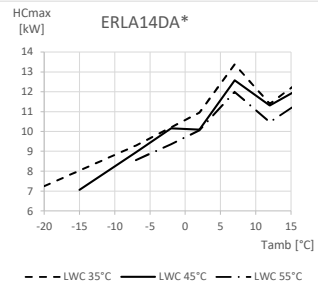
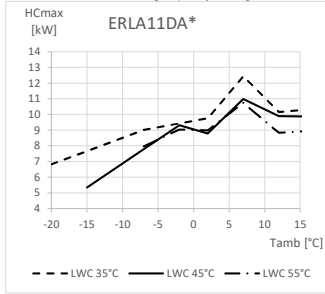

Maximum heating capacity - peak values

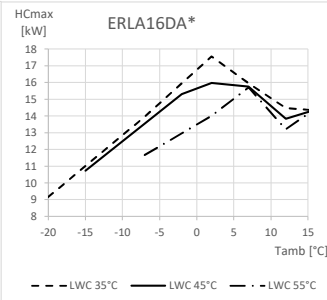
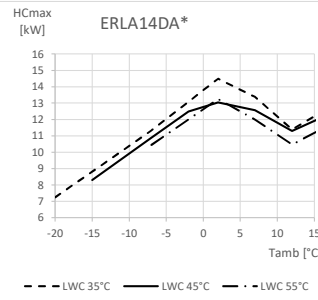
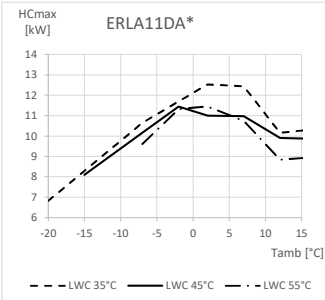

Symbols

- HC_{max} Heating capacity for maximum load, measured according to EN 14511
- LWC Leaving water condensor temperature [°C]
- Tamb Ambient temperature [°C DB]

Conditions

- Heating capacity
- Capacity according to standard EN 14511 and valid for heated water range $\Delta T = 3^{\circ}8^{\circ}C$.

Notes

- The capacity and power input is valid for -V3- models at -230-V and for for -W1- models at -400-V.
- The capacity and the power input are at maximum operation.

4D137448

4 Capacity graphs

4 - 3 Heating Capacity Graphs - quiet mode

ERLA11-16DV3
ERLA11-16DW1

Maximum heating capacity - integrated value

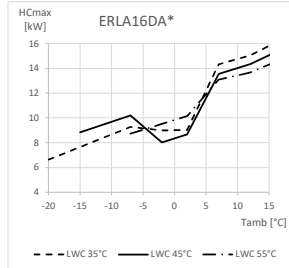
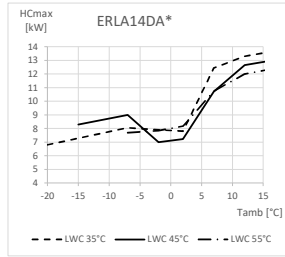
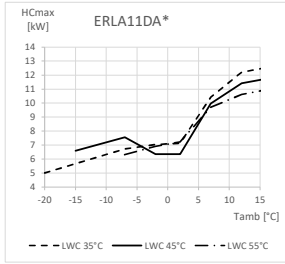

Maximum heating capacity - peak values

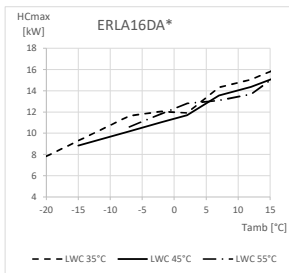
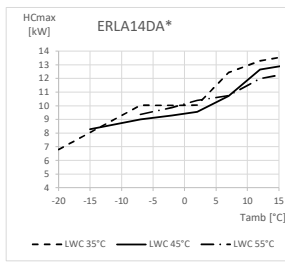
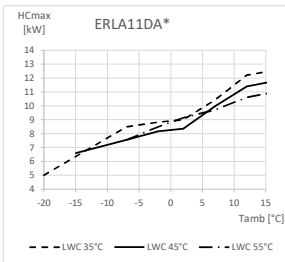

Symbols

HC_{max} Heating capacity for maximum load, measured according to EN 14511
LWC Leaving water condensor temperature [°C]
Tamb Ambient temperature [°C DB]

Conditions

Heating capacity

Capacity according to standard EN 14511 and valid for heated water range ΔT = 3~8°C.

Notes

The capacity and power input is valid for -V3- models at 230-V and for for -W1- models at 400-V.
The capacity and the power input are at maximum operation.

4D137449

5 Capacity tables

5 - 1 Certification Programs

5

ERLA11-16DV3 ERLA11-16DW1

Rated data for certification programmes - domestic hot water performance

Outdoor unit Domestic hot water tank Tapping pattern	ERLA11/14/16DAV3 EBV(H/X/Z)(11/16)S18D1(6V/9W)			ERLA11/14/16DAW1 EBV(H/X/Z)(11/16)S(U)23D1(6V/9W)		
	L	L	XL	L	L	XL
Application	Average climate (design temperature: -7 °C)					
COP _{DHW} []	2,73	2,80	2,63	2,77	2,84	2,64
η _{wh} [%]	115,6%	119,3%	108,7%	116,4%	119,9%	109,0%
AEC [kWh]	886	858	1542	879	854	1537
Application	Colder climate (design temperature: -2 °C)					
COP _{DHW} []	2,24	2,31	2,08	2,26	2,33	2,09
η _{wh} [%]	94,2%	97,3%	85,3%	94,6%	97,7%	85,5%
AEC [kWh]	1087	1053	1963	1082	1048	1959
Application	Warmer climate (design temperature: -14 °C)					
COP _{DHW} []	3,26	3,46	3,00	3,32	3,51	3,02
η _{wh} [%]	138,8%	147,8%	124,1%	139,8%	148,9%	124,5%
AEC [kWh]	737	692	1349	732	688	1345

Indoor Unit Outdoor Unit Tapping pattern	EBS(X/H)(B/-)(11/16)P30DF ERLA11/14/16DAV3		EBS(X/H)(B/-)(11/16)P50DF ERLA11/14/16DAW1	
	L	XL	L	XL
Application	Average climate (design temperature: -7 °C)			
COP _{DHW} []	2,73	2,75	3,05	3,1
η _{wh} [%]	115%	116%	126%	128%
AEC [kWh]	890	887	1329	1313
Application	Colder climate (design temperature: -2 °C)			
COP _{DHW} []	2,32	2,33	2,63	2,67
η _{wh} [%]	97%	98%	109%	110%
AEC [kWh]	1053	1051	1542	1526
Application	Warmer climate (design temperature: -14 °C)			
COP _{DHW} []	3,2	3,24	3,68	3,76
η _{wh} [%]	136%	137%	153%	155%
AEC [kWh]	753	750	1094	1078

3D136699C

ERLA11-16DV3 ERLA11-16DW1

Rated data for certification programmes - heating mode

Tamb [°C]	EWC [°C]	LWC [°C]	ERLA11DAV3		ERLA14DAV3		ERLA16DAV3		ERLA11DAW1		ERLA14DAW1		ERLA16DAW1		Used for:
			HC [kW]	COP [-]	HC [kW]	COP [-]	HC [kW]	COP [-]	HC [kW]	COP [-]	HC [kW]	COP [-]	HC [kW]	COP [-]	
10/9	30	35	9,20	5,32	9,20	5,32	9,20	5,32	9,20	5,32	9,20	5,32	9,20	5,32	BAFA
7/6	30	35	10,56	4,83	12,00	4,87	16,00	4,53	10,56	4,83	12,00	4,87	16,00	4,53	Keymark, EHPA, BAFA, GET
2/1	(30)	35	9,00	3,65	10,80	3,50	12,00	3,30	9,00	3,65	10,80	3,50	12,00	3,30	EHPA, GET
2/1	(30)	35	6,29	4,01	6,29	4,01	6,29	4,01	6,29	4,01	6,29	4,01	6,29	4,01	BAFA
-7/-8	(30)	35	8,75	2,92	9,30	2,86	10,60	2,70	8,75	2,92	10,50	3,00	12,30	2,87	EHPA, BAFA, GET
7/6	40	45	9,82	3,66	12,45	3,64	16,00	3,51	9,82	3,66	12,45	3,64	16,00	3,51	EHPA
-2/-3	(40)	45	9,32	2,57	10,15	2,58	11,91	2,42	9,32	2,57	10,15	2,58	11,91	2,42	MCS
-7/-8	(40)	45	8,72	2,35	8,98	2,29	10,49	2,10	8,72	2,35	8,98	2,29	10,49	2,10	EHPA
7/6	47	55	10,64	2,94	11,87	2,89	15,63	2,75	10,64	2,94	11,87	2,89	15,63	2,75	Keymark, EHPA, GET
-7/-8	47	55	7,89	1,82	8,47	1,82	8,87	1,78	7,89	1,82	8,47	1,82	8,87	1,78	GET, EHPA

Rated data for certification programmes - cooling mode

Nominal cooling capacity										
Tamb [°C]	EWE [°C]	LWE [°C]	ERLA11DA(V3/W1)		ERLA14DA(V3/W1)		ERLA16DA(V3/W1)		Used for:	
			CC [kW]	EER [-]	CC [kW]	EER [-]	CC [kW]	EER [-]		
35	23	18	11,85	4,7	13,18	4,61	15,72	4,11	General	DAI
35	12	7	11,18	3,22	12,92	2,98	13,63	2,91	Keymark	DAPT

Symbols

- HC Heating capacity measured according to EN 14511
- CC Cooling capacity, measured according to EN 14511.
- COP/EER Coefficient of Performance/Energy efficiency ratio according to EN 14511.

- EWC Entering water condenser temperature [°C]
- LWC Leaving water condenser temperature [°C]
- EWE Entering water evaporator temperature [°C]
- LWE Leaving water evaporator temperature [°C]
- Tamb Ambient temperature [°C DB/WB]
- Pdes Nominal capacity value at design temperature [kW]
- SEER Seasonal energy efficiency ratio according to EN14825-
- η_{sc} Seasonal space cooling energy efficiency according to EN14825-
- Q_{sc} Annual energy consumption for cooling according to EN14825-

	Application		
	ERLA11DA(V3/W1)	ERLA14DA(V3/W1)	ERLA16DA(V3/W1)
Pdes [kW]	11	12,9	13,600
SEER [-]	5,92	5,86	5,76
η _{sc} [-]	234	231	227
Q _{sc} [kWh/annum]	1116	1322	1417

Rated data for certification programmes - standby power consumption

Standby power input	ERLA11/14/16DA(V3/W1)		Used for:
	[W]	23	

3D136699C

5 Capacity tables

5 - 2 Domestic Hot Water performance

ERLA11-16DV3
ERLA11-16DW1

Heat-up times

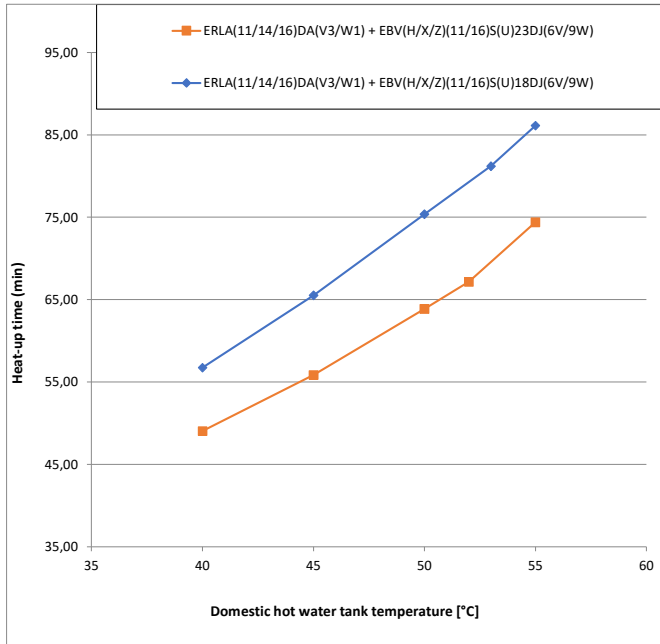

Model name	Heat-up time domestic hot water tank until 45°C
ERLA(11/14/16)DA(V3/W1) + EBV(H/X/Z)(11/16)S(U)18DJ(6V/9W)	62 min.
ERLA(11/14/16)DA(V3/W1) + EBV(H/X/Z)(11/16)S(U)23DJ(6V/9W)	56 min.

Notes

1. Time the indoor unit (**heat pump only operation**) requires to heat up the domestic hot water tank from 10°C to the indicated temperature. See the operation range for maximum domestic hot water tank temperature during heat pump only operation.

Selection guide for the domestic hot water tank volume

(1)

Ve_q 40°C = the amount of water with a temperature of 40°C that can be tapped when the domestic hot water tank is heated to a certain temperature, and the temperature of the cold inlet water is 10°C.

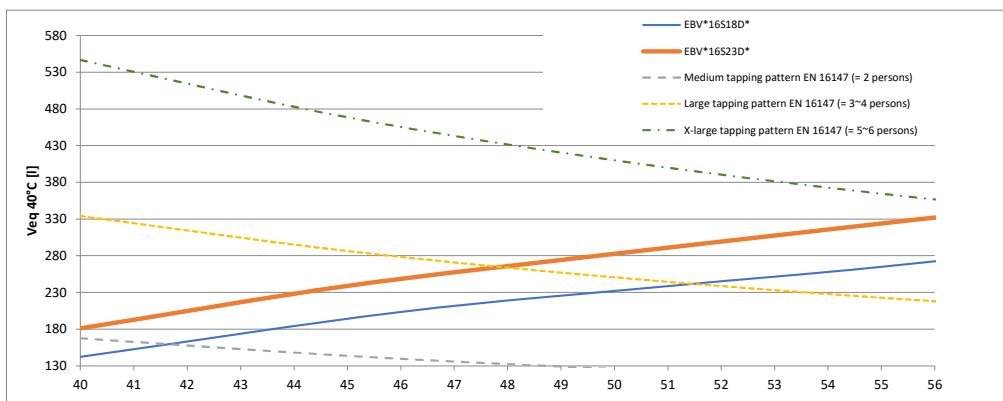

If a higher daily Ve_q 40°C is required, then additional heat-up cycles are required within 24 hours. See the operation manual for more information.

Notes

- (1) According to EN16147.

4D136698

6 Dimensional drawings

6 - 1 Dimensional Drawings

ERLA11-16DV3

ERLA11-16DW1

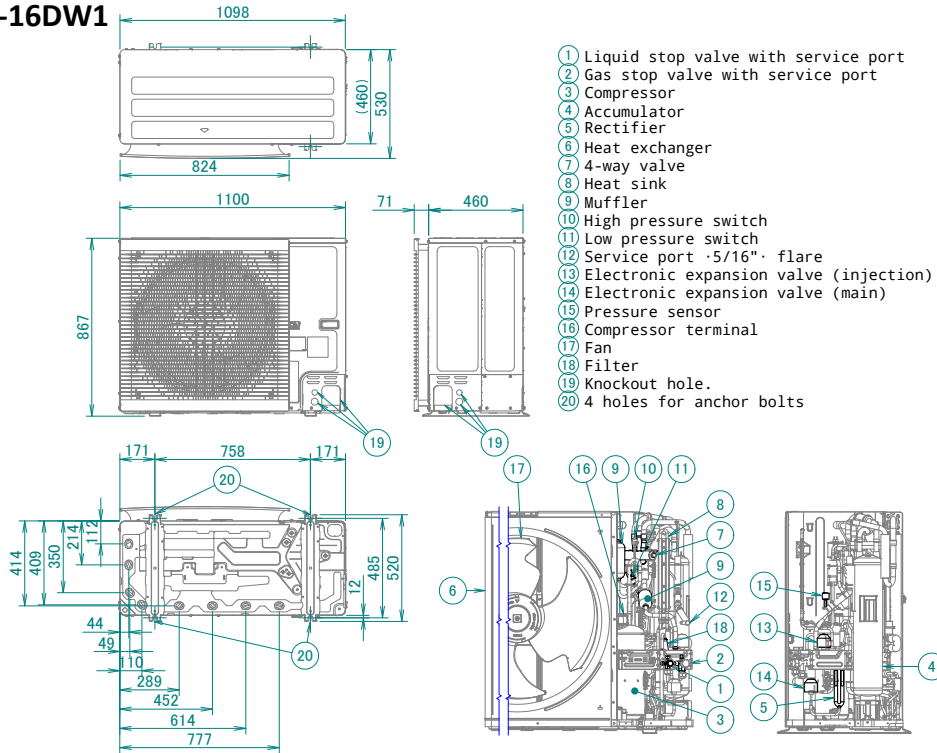

3D136425

7 Centre of gravity

7 - 1 Centre of Gravity

7

ERLA11-16DV3

ERLA11-16DW1

3~

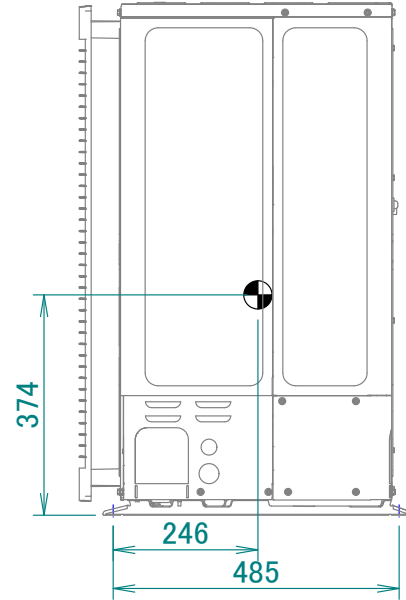
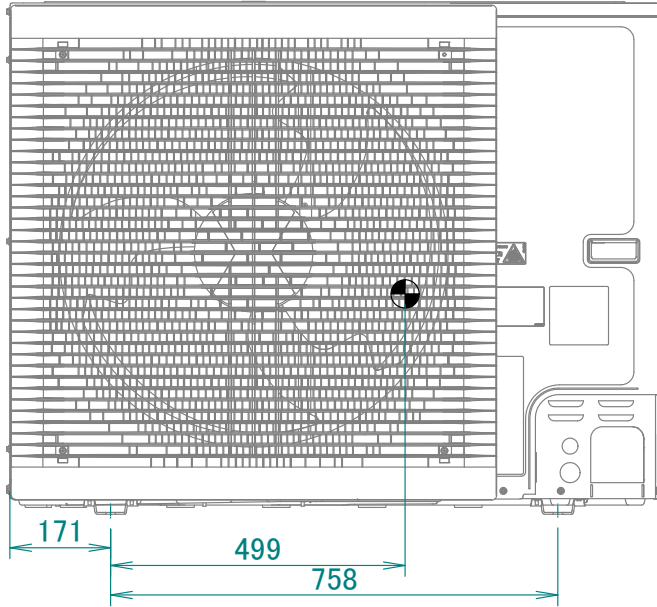

1~

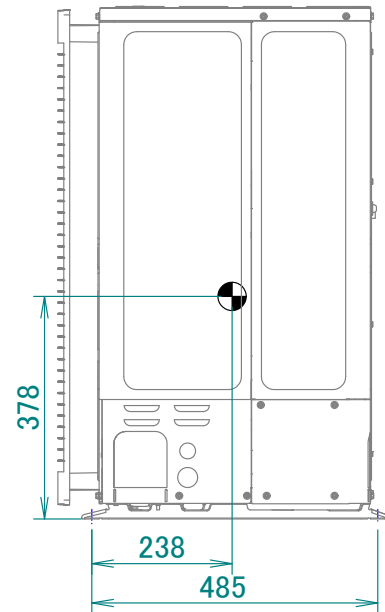
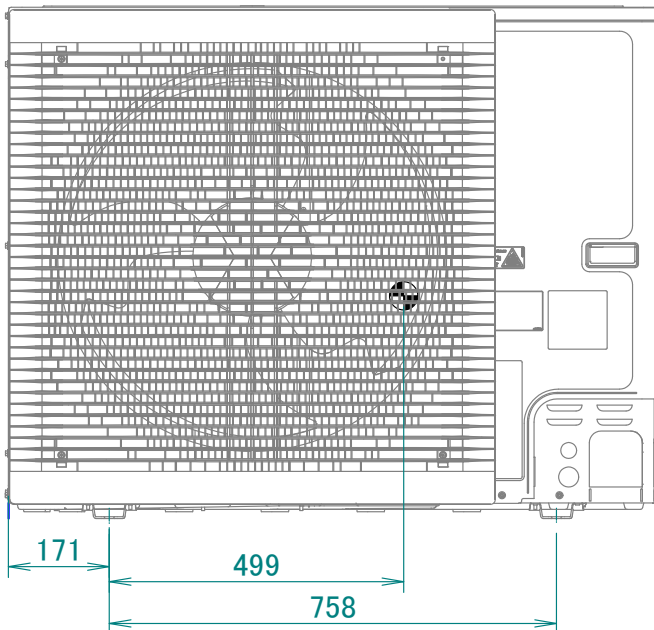

4D136430

8 Piping diagrams

8 - 1 Piping Diagrams

ERLA11-16DV3
ERLA11-16DW1

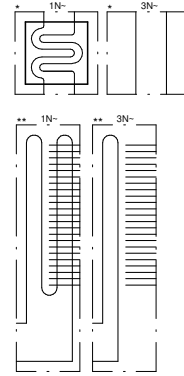
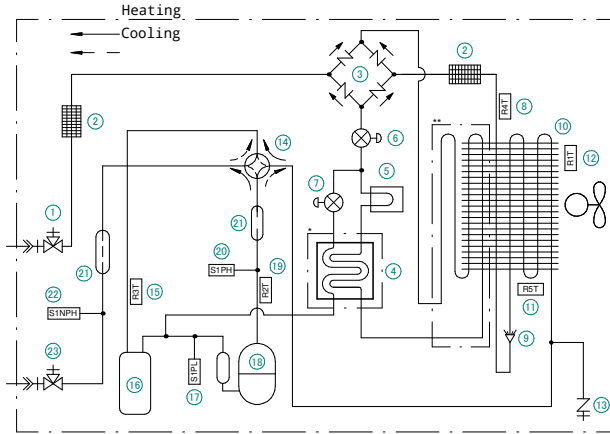
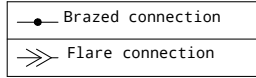

- | | |
|---|--|
| <ul style="list-style-type: none"> ① Liquid stop valve with service port ② Filter ③ Rectifier ④ Economiser ⑤ Heat sink ⑥ Electronic expansion valve (main) ⑦ Electronic expansion valve (injection) ⑧ R4T- Thermistor (heat exchanger) ⑨ Distributor ⑩ Heat exchanger ⑪ RST- Thermistor (heat exchanger middle) ⑫ R1T- Outdoor air ⑬ Service port ·5/16"· flare ⑭ 4-way valve ⑮ R3T- Thermistor (suction) ⑯ Accumulator | <ul style="list-style-type: none"> ⑰ Low pressure switch ⑱ Compressor ⑲ R2T- Thermistor (discharge) ⑳ High pressure switch ㉑ Muffler ㉒ Pressure sensor ㉓ Gas stop valve with service port |
|---|--|

3D131968

9 Wiring diagrams

9 - 1 Notes & Legend

9

ERLA11-16DV3 / ERLA11-16DW1

NOTES to go through before starting the unit

- X1M : Main terminal
- : Earth wiring
- - - - - : Field supply
- ① : Several wiring possibilities
- [Option symbol] : Option
- [Wiring depending on model symbol] : Wiring depending on model
- [Not mounted in switch box symbol] : Not mounted in switch box
- [PCB symbol] : PCB

NOTES

1. Refer to the wiring diagram sticker (on the back of the front plate) for how to use the BS1~BS4 and DS1 switches.
2. When operating, do not short-circuit protection device Q1, S1PH and S1PL.
3. Refer to the combination table and the option manual for how to connect the wiring to X6A, X41A and X77A.
4. Colours: BLK: black; RED: red; BLU: blue; WHT: white; GRN: green; BRN: brown; YLW: yellow; ORG: orange
5. Confirm the method of setting the selector switches (DS1) by service manual. Factory setting of all switches: OFF

POSITION IN SWITCH BOX

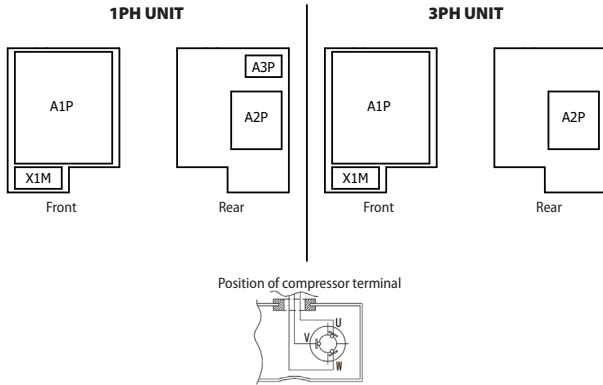

LEGEND

1PH UNIT		3PH UNIT	
Part n°	Description	Part n°	Description
A1P	Printed circuit board (main)	A1P	Printed circuit board (main)
A2P	Printed circuit board (noise filter)	A2P	Printed circuit board (noise filter)
A3P	Printed circuit board (flash)	C* (A1P)	Capacitor
C* (A*P)	Capacitor	BS* (A1P)	Push button switch
BS* (A1P)	Push button switch	DS1 (A1P)	Dipswitch
DS1 (A1P)	Dipswitch	F1U, F3U (A2P)	Fuse T 6,3 A 250 V
F1U, F3U~F4U (A2P)	Fuse T 6,3 A 250 V	F4U, F5U (A2P)	Fuse T 30 A 500 V
F2U (A2P)	Fuse T 56 A 250 V	F7U (A1P)	Fuse T 5 A 250 V
F6U (A1P)	Fuse T 5 A 250 V	HAP (A1P)	Light emitting diode (service monitor is green)
H1~7P (A1P)	Indication light emitting diode (service monitor is orange)	K1R (A1P)	Magnetic relay (Y1S)
HAP (A1P)	Light emitting diode (service monitor is green)	K5~8R (A1P)	Magnetic relay
K1R (A1P)	Magnetic relay (Y1S)	K*M (A1P)	Magnetic relay (Main)
K10R (A1P)	Magnetic relay	L*R (A*P)	Reactor
K11M (A1P)	Magnetic relay (Main)	M1C	Compressor motor
K14~15R (A2P)	Magnetic relay	M1F	Fan motor
L*R (A1P)	Reactor	PS (A1P)	Switching power supply
M1C	Compressor motor	Q1	Thermal overcurrent protector
M1F	Fan motor	Q1DI	# Earth leakage circuit breaker (30mA)
PS (A1P)	Switching power supply	R1~5 (A*P)	Resistor
Q1	Thermal overcurrent protector	R1T	Thermistor (air)
Q1DI	# Earth leakage circuit breaker (30mA)	R2T	Thermistor (discharge)
R1~5 (A*P)	Resistor	R3T	Thermistor (suction)
R1T	Thermistor (air)	R4T	Thermistor (distribution pipe)
R2T	Thermistor (discharge)	R5T	Thermistor (heat exchanger middle)
R3T	Thermistor (suction)	R11T (A1P)	Thermistor (fin)
R4T	Thermistor (distribution pipe)	RC (A2P)	Signal receiver circuit
R5T	Thermistor (heat exchanger middle)	S1NPH	Pressure sensor
R11T (A1P)	Thermistor (fin)	S1PH	High pressure switch
RC (A2P)	Signal receiver circuit	S1PL	Low pressure switch
S1NPH	Pressure sensor	SEG* (A1P)	7-segment display
S1PH	High pressure switch	TC (A1P)	Signal transmission circuit
S1PL	Low pressure switch	V*D (A1P)	Diode
SEG* (A1P)	7-segment display	V1~2R (A1P)	Diode module
TC (A1P)	Signal transmission circuit	V3~5R (A1P)	Power module
V*D (A1P)	Diode	X1M	Terminal strip
V1~2R (A1P)	Diode module	X*A, X*Y (A*P)	Connector
V3~5R (A1P)	Power module	Y1E, Y3E	Electronic expansion valve
X1M	Terminal strip	Y1S	Solenoid valve (4-way valve)
X*A, X*Y (A*P)	Connector	Z*C	Noise filter (ferrite core)
Y1E, Y3E	Electronic expansion valve	Z*F (A*P)	Noise filter
Y1S	Solenoid valve (4-way valve)		
Z*C	Noise filter (ferrite core)		
Z*F (A*P)	Noise filter		

* : optional # : field supply

4D132942A

9 Wiring diagrams

9 - 2 Compressor - Single phase

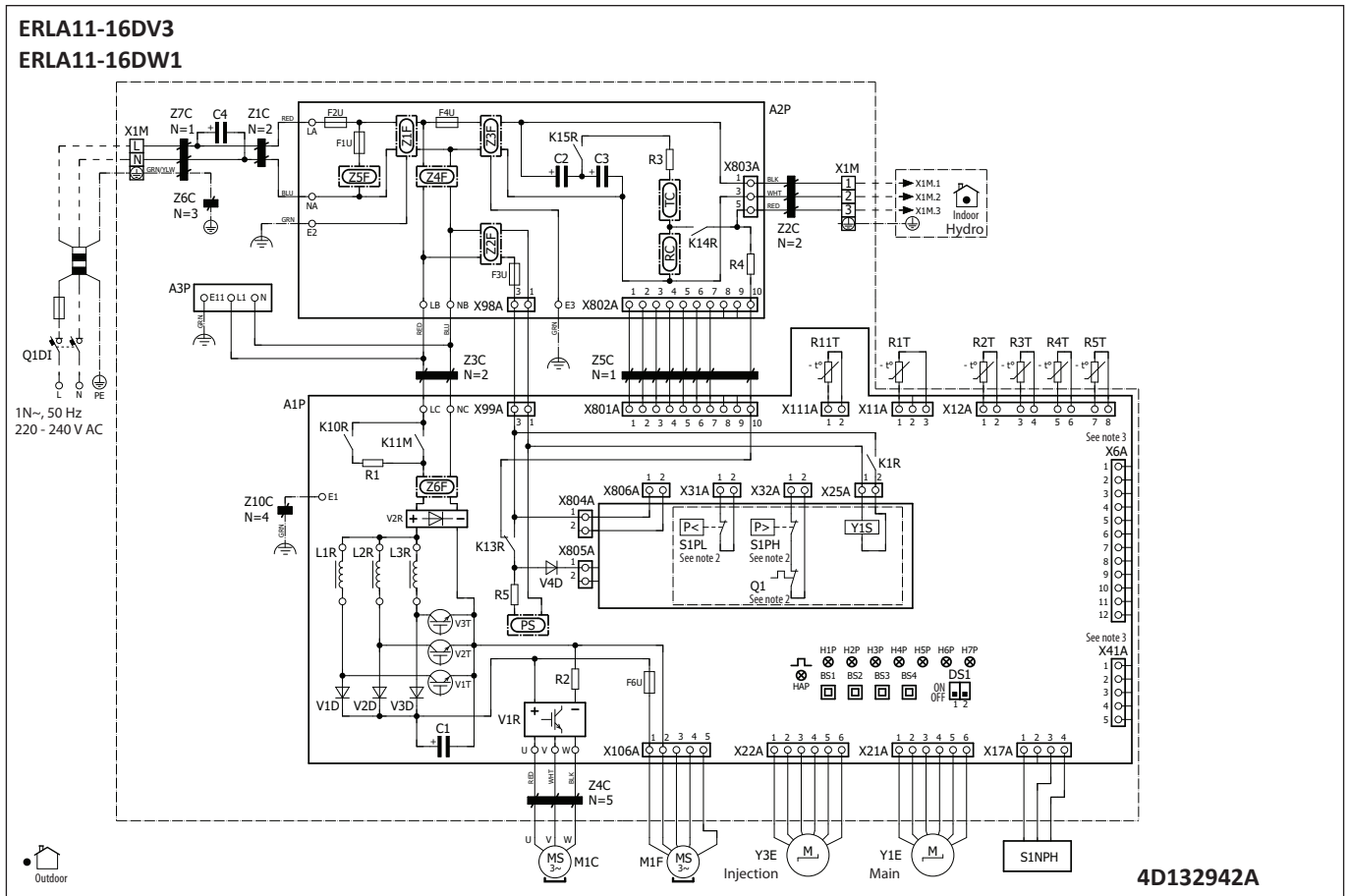

9 Wiring diagrams

9 - 3 Compressor - Three phase

9

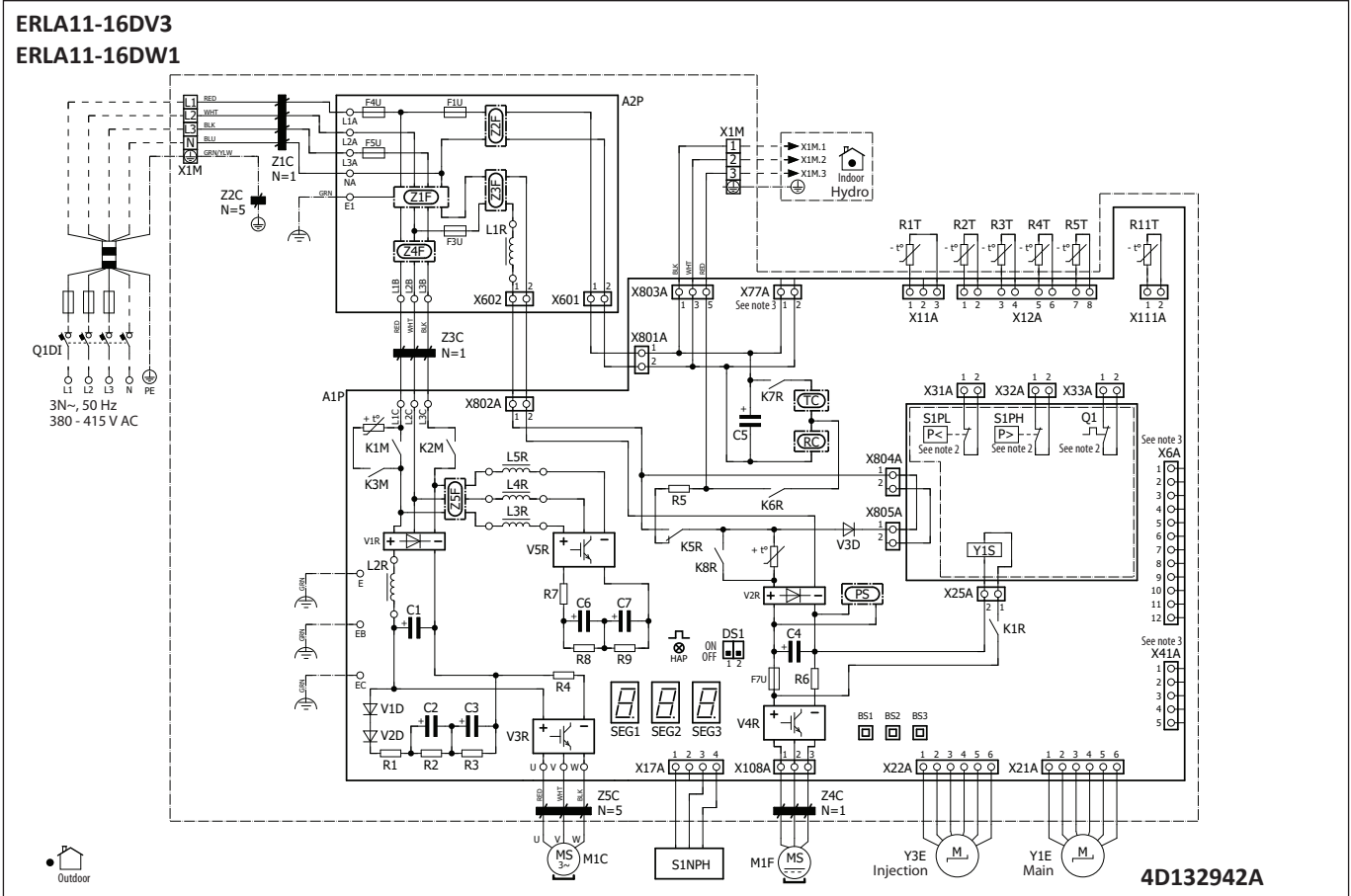

10 Sound data

10 - 1 Sound Pressure Spectrum - Cooling

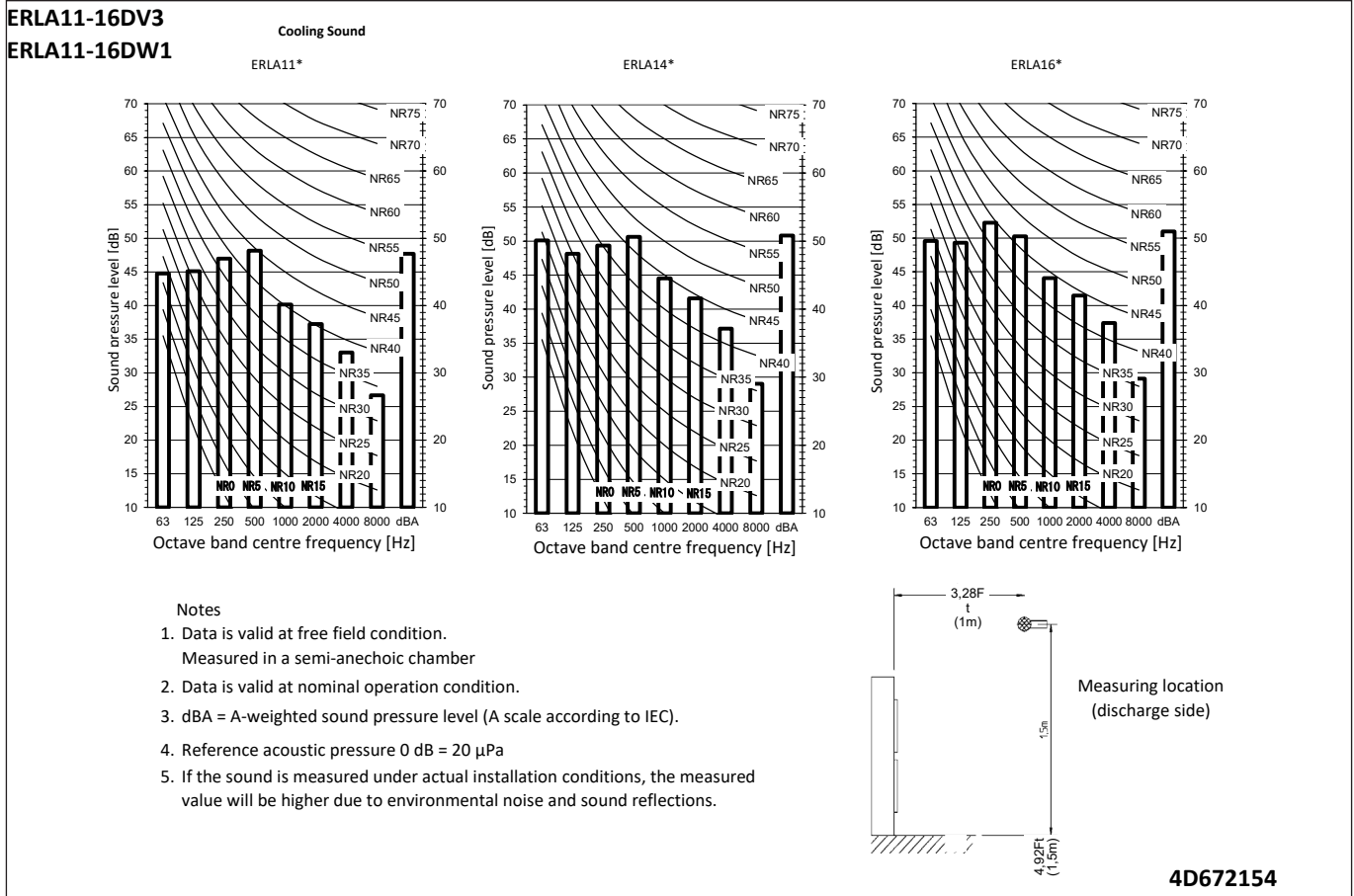

10 Sound data

10 - 2 Sound Pressure Spectrum - Heating

10

ERLA11-16DV3
ERLA11-16DW1

Heating Sound

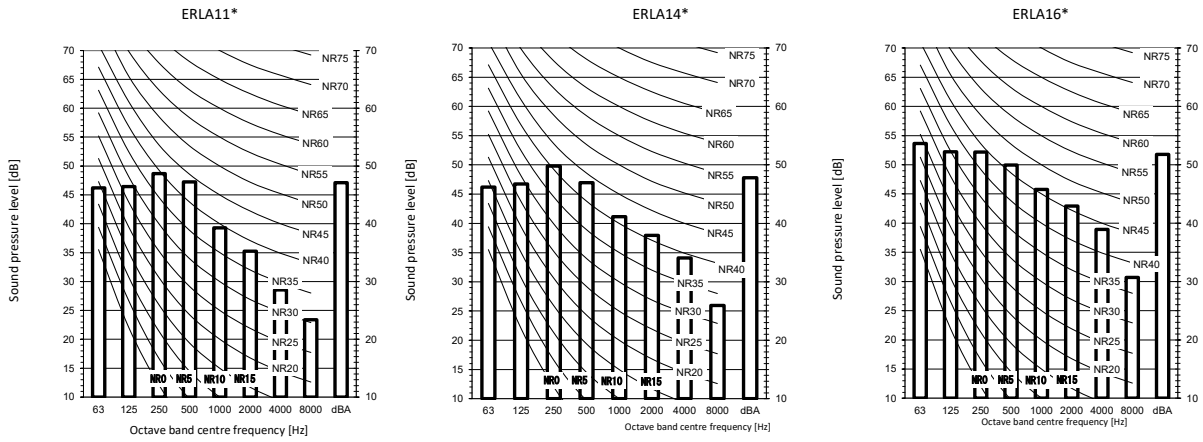

Notes

1. Data is valid at free field condition.
2. Data is valid at nominal operation condition.
3. dBA = A-weighted sound pressure level (A scale according to IEC).
4. Reference acoustic pressure 0 dB = 20 μPa
5. If the sound is measured under actual installation conditions, the measured value will be higher due to environmental noise and sound reflections.

		Maximum sound day			Maximum sound night		
		Sound Power Level [dBA]			Sound Power Level [dBA]		
Maximum sound day	Maximum sound night	ERLA11*	ERLA14*	ERLA16*	ERLA11*	ERLA14*	ERLA16*
Default	Low noise level -1-	68	69	73	62	62	62
	Low noise level -2-						

Full load (maximum fan rps and maximum compressor rps for the dedicated low noise mode)

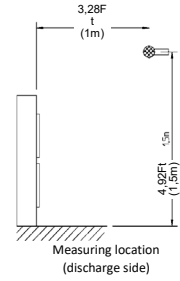

4D672156A

10 Sound data

10 - 3 Sound Pressure Spectrum Quiet Mode

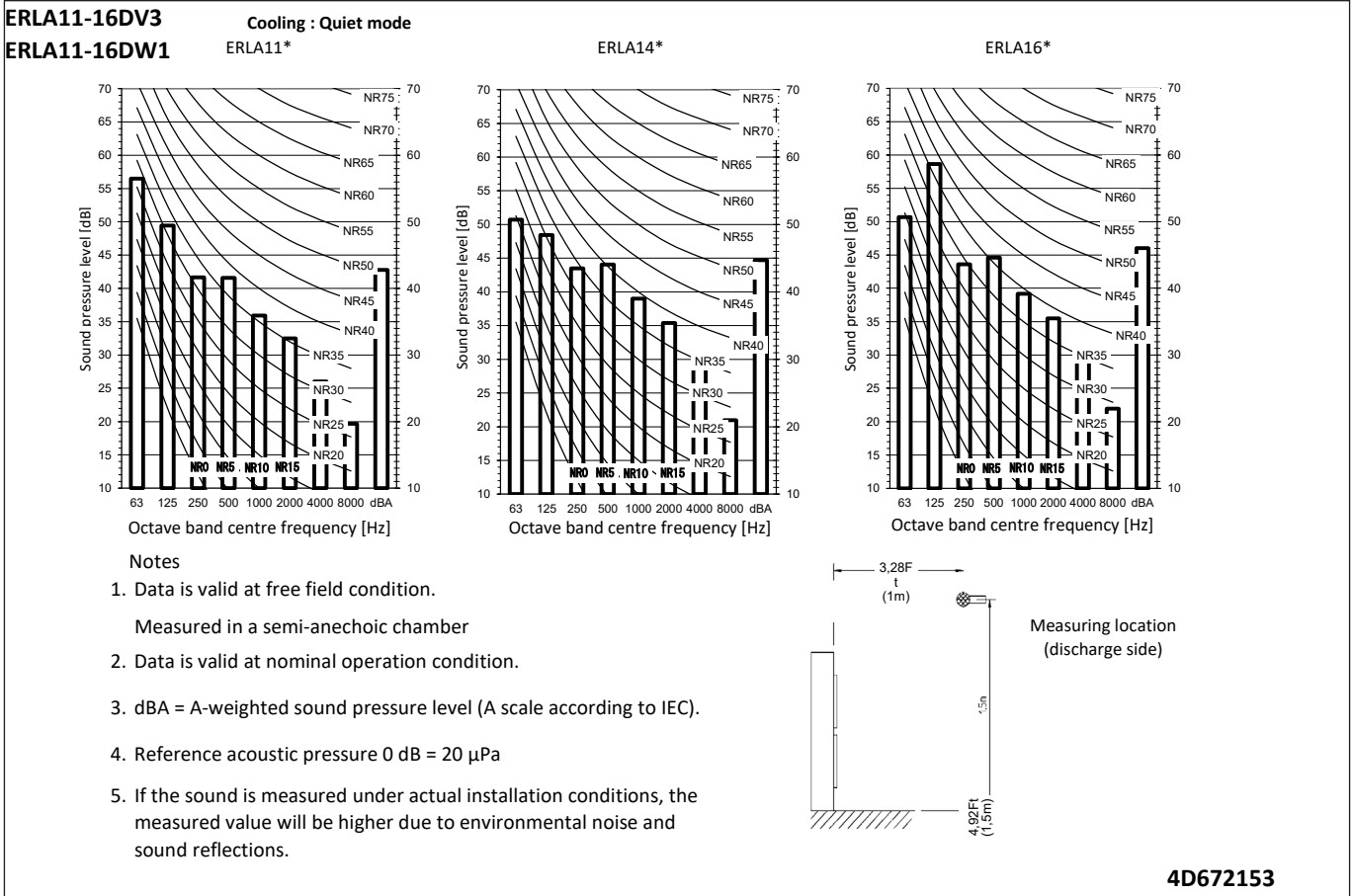

10

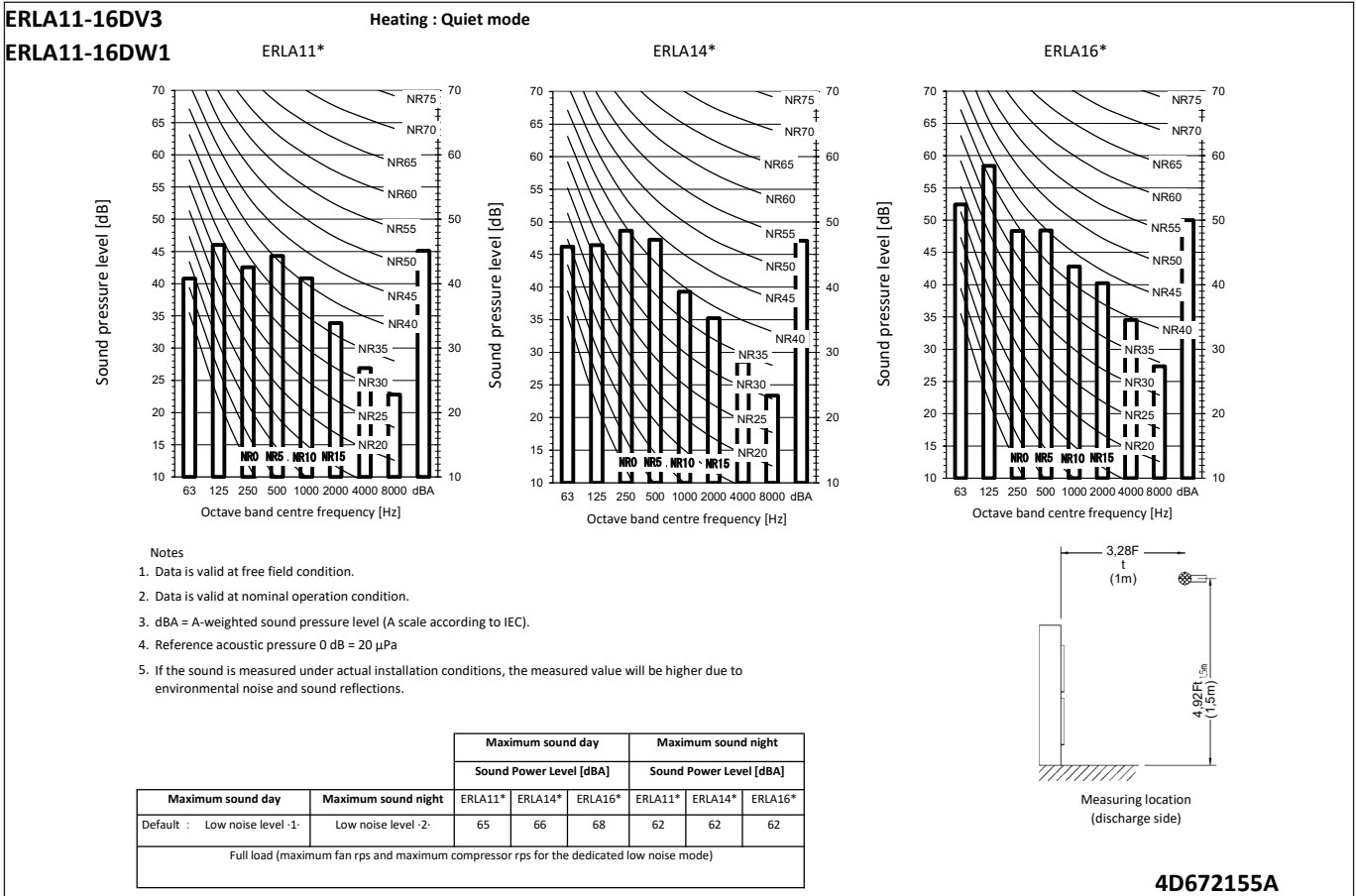

11 Installation

11 - 1 Installation Method

11

ERLA11-16DV3
ERLA11-16DW1

	Suction-side obstacle	Discharge-side obstacle	Suction-side obstacle + Discharge-side obstacle
Top-side obstacle			
No top-side obstacle			

General

3D135843

12 Operation range

12 - 1 Operation Range

ERLA11-16DV3
ERLA11-16DW1

EBV* + EBB* + EBS*

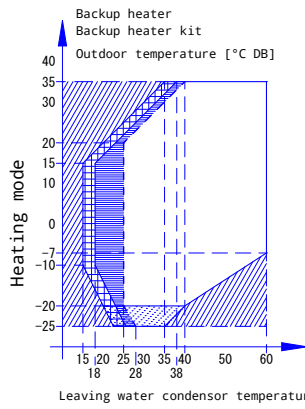

Legend

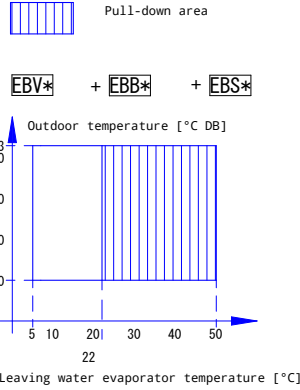

EBS*

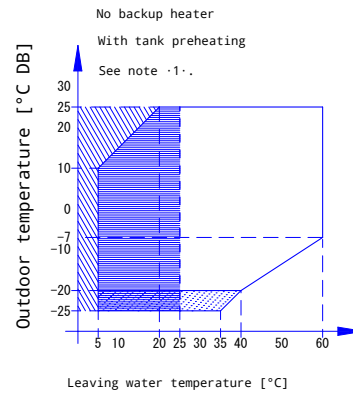

Legend

- Backup heater only operation
No outdoor unit operation
- Heat pump + backup heater operation
Pull-up area
- Outdoor unit operation if controller setpoint is regulated to minimal leaving water temperature request.
See dashed lines
- Operation of outdoor unit possible, but with possible capacity reduction.
- Circulation pump operation only

Notes

1. Tank preheating
For details, see the installer reference guide.
2. In restricted power supply mode, the outdoor unit and backup heater can only operate separately.

3D136633A

ERLA11-16DV3
ERLA11-16DW1

Legend

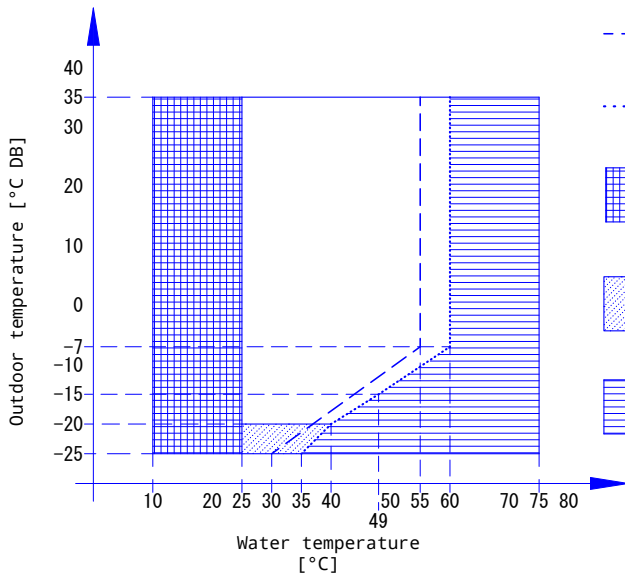

- Setpoint [°C]
Domestic hot water
- Leaving water temperature [°C]
- Pull-up area
- Operation of outdoor unit possible, but with possible capacity reduction.
- Booster heater only operation
(if a booster heater is part of the system)

Notes

1. In restricted power supply mode (·EKHW*· only), the outdoor unit, booster heater and backup heater can only operate separately.
2. Third-party with identical specifications as ·EKHS*·
Coil surface >·1.05·m² and <·3.7·m²
Tank thermistor and booster heater above heat pump coil.
3. If negative ambient temperatures are expected, both in operation or at standstill, take adequate countermeasures against freezing.
For more information, refer to the installation manual.

3D130989A

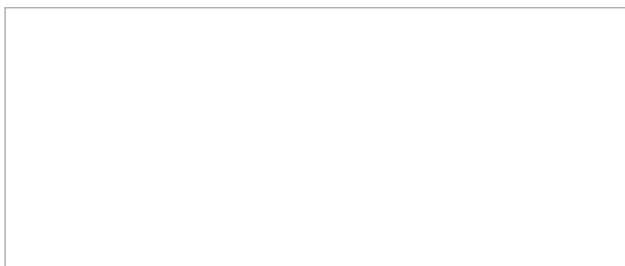

EEEDEN22



02/2022



The present publication is drawn up by way of information only and does not constitute an offer binding upon Daikin Europe N.V. / Daikin Central Europe HandelsGmbH. Daikin Europe N.V. / Daikin Central Europe HandelsGmbH have compiled the content of this publication to the best of their knowledge. No express or implied warranty is given for the completeness, accuracy, reliability or fitness for particular purpose of its content and the products and services presented therein. Specifications are subject to change without prior notice. Daikin Europe N.V. / Daikin Central Europe HandelsGmbH explicitly rejects any liability for any direct or indirect damage, in the broadest sense, arising from or related to the use and/or interpretation of this publication. All content is copyrighted by Daikin Europe N.V.